



ACCESSORI

VA.ILA S.p.a. 2023 [11]



LISTINO IN VIGORE DAL 01/06/2023 ANNULLA E SOSTITUISCE TUTTI I PRECEDENTI

12-10-23

NOTA IMPORTANTE!

PER TUTTI GLI ORDINI INVIATI, RICEVERETE LA CONFERMA D'ORDINE VIA EMAIL.

LA STESSA DOVRA ESSERE INOLTRATA CONTROFIRMATA PER ACCETTAZIONE.

PER QUALUNQUE INCONGRUENZA TRA LA CONFERMA D'ORDINE E L'ORDINE (SIA NEI DATI CHE NEI PREZZI) FARA' FEDE LA CONFERMA D'ORDINE.

VI ESORTIAMO QUINDI A VOLER CONTROLLARE ESSA IN OGNI SUA PARTE E DARCI TEMPESTIVA COMUNICAZIONE DI EVENTUALI INCONGRUENZE.

CARATTERISTICHE DEI PRODOTTI: i disegni contenuti nel presente listino sono puramente indicativi, pertanto la nostra azienda si riserva il diritto di apportare modifiche migliorative dei prodotti senza nessun obbligo di preavviso.



La merce viaggia a rischio e pericolo del committente anche se venduta "franco destino".

Gli ordini dovranno essere trasmessi esclusivamente per iscritto a mezzo fax, o on-line, in caso contrario non ci riterremo responsabili della loro errata esecuzione. L'eventuale annullamento di un ordine dovrà essere effettuato per iscritto e/o a mezzo fax o on-line. Non sono incluse nel prezzo di listino eventuali lavori particolari. Ci si riserva l'annullamento di un ordine per causa di forza maggiore.

L'uso improprio della merce fornita e/o il suo utilizzo in particolari condizioni climatiche ed ambientali non comporta alcuna responsabilità riconducibile al venditore.

L'esecuzione parziale e ritardata dell'ordine non dà diritto ad annullamenti di qualsiasi genere, né ad eventuali rivalse.

La merce lasciata in riparazione o in sostituzione e non ritirata entro i 30 giorni successivi alla data prevista per la consegna potrà essere avviata al macero.

Gli eventuali reclami dovranno essere motivati e proposti, pena la decadenza, entro 5 giorni dall'arrivo della merce esclusivamente per mezzo di lettera raccomandata. Trascorso tale termine la merce si intende definitivamente accettata dall'acquirente. Si intende ugualmente accettata la merce che l'acquirente abbia utilizzato in tutto o in parte. I reclami della merce, se fondati, danno diritto soltanto alla sostituzione o alla resa della stessa, senza alcun indennizzo.

I prezzi del presente listino sono al netto dell' I.V.A. e potranno essere variati senza nessun preavviso.

Il ritardo del pagamento, rispetto i termini concordati, comporta l'obbligo per l'acquirente di corrispondere l'interesse bancario secondo i tassi correnti.

Per qualsiasi controversia si farà riferimento all' Autorità Giudiziaria competente nel territorio del venditore.

Eventuali resi dovranno essere autorizzati dall'azienda o dal personale autorizzato.

I resi verranno accettati solo se accompagnati dal Documento di Trasporto e relative descrizioni.

L' Azienda si riserva di perfezionare le nuove forniture solo quando siano stati effettuati i pagamenti dovuti.

La merce rimane proprietà dell'azienda fino al completo pagamento.



GENERAL CONDITIONS OF SALE

The goods travel at the risk and peril of the customer even if sold "free at destination".

Orders must be sent in writing only by fax, or online, otherwise we will not be responsible for their incorrect execution. Any cancellation of an order must be made in writing and / or by fax or online. Any special works are not included in the list price. We reserve the right to cancel an order due to force majeure.

The improper use of the supplied goods and / or its use in particular climatic and environmental conditions does not imply any responsibility attributable to the seller.

The partial and delayed execution of the order does not give the right to cancellations of any kind, nor to any recourse.

The goods left in repair or in replacement and not withdrawn within 30 days after the scheduled delivery date can be sent for recycling.

Any complaints must be motivated and proposed, under penalty of forfeiture, within 5 days of the arrival of the goods exclusively by registered letter. After this deadline the goods are considered definitively accepted by the buyer. The goods that the buyer has used in whole or in part are also considered accepted. Claims of the goods, if founded, only entitle them to be replaced or returned, without compensation.

The prices in this price list are net of I.V.A. and may be changed without prior notice.

The delay in payment, with respect to the agreed terms, involves the obligation for the buyer to pay the bank interest according to current rates.

For any dispute, reference will be made to the competent judicial authority in the territory of the seller.

Any returns must be authorized by the company or authorized personnel.
Returns will be accepted only if accompanied by the Transport Document and related descriptions.
The Company reserves the right to finalize new supplies only when payments have been made.
The goods remain the property of the company until full payment.



CONDITIONS GENERALES DE VENTE

La marchandise voyage au risque et au danger de l'acheteur, même si vendue "franco destination".

Les commandes doivent être transmises uniquement par écrit et par fax, autrement nous ne serons pas responsables de leur mauvaise exécution. Toute annulation d'une commande doit être faite par écrit et/ou par télécopieur. Ne sont pas inclus dans la liste des prix les travaux de maçonnerie, d'électricité, de soudure et plaques spéciales. Nous nous réservons l'annulation d'une commande en raison de force majeure.

Une utilisation incorrecte de la marchandise livrée et / ou son utilisation dans des conditions climatiques particulières et environnementales ne comporte pas aucune responsabilité imputable au vendeur.

L'exécution partielle et retardée de la commande ne donne pas droit à des annulations de toute nature, ni à des représailles.

La marchandise laissée en réparation et pas retirée dans les 30 jours suivants la date prévue pour la livraison pourra être initiée à la macération.

Toutes les plaintes doivent être motivées et proposées, peine de déchéance, dans les 5 jours suivants l'arrivée de la marchandise exclusivement au moyen d'une lettre recommandée. Après ce temps, la marchandise est définitivement acceptée par l'Acheteur. On entend aussi acceptés les marchandises que l'Acheteur a utilisés, en tout ou en partie. Les plaintes des marchandises, si fondées, donnent le droit uniquement au remplacement ou à la remise de la même, sans aucune compensation.

Les prix mentionnés dans cette liste de prix sont hors TVA et sont sujets à changement sans préavis.

Le retard du paiement, par rapport aux modalités convenues, implique l'obligation de l'acheteur de payer les intérêts de la banque selon les tarifs en vigueur.

Tout litige sera soumis à l'autorité judiciaire compétente sur le territoire de la vente.

Les retours doivent être autorisés par la Société ou par le personnel autorisé.
Les retours ne seront acceptés que se ils sont accompagnés par le document de transport et les descriptions.
La Société se réserve de perfectionner les nouveaux approvisionnements seulement quand ils ont été effectués les paiements dus.
Les marchandises restent la propriété de la société jusqu'au complet paiement.

INDICE / INDEX / INDEX

TENDE A CADUTA / DROP AWNINGS / STORES EXTERIEUR

■ TNR - TCN - TM	6
■ TMS	14
■ TMS SILVER	18
■ TB FIRENZE	22
■ P-GOLD	24
■ TORTIGLIONE	28
■ VENEZIA	30
■ TCL ALFA - BETA	36
■ TCL GAMMA	40
■ TCL OMEGA	44

TENDE PER ATTICO / ATTIC AWNINGS / STORES VERANDAS

■ TMT	48
■ TMT PLUS	52
■ GARDEN	56
■ NEW GARDEN	60
■ RAFFAELLO	64

TENDE A BRACCI / FOLDING ARM AWNINGS / STORES A BRAS

■ BQC LUX	68
■ BQC COMPACT	74
■ EUROPE SHADOW	80
■ KENIA	84
■ BQ 40 PLUS	90
■ SPAGNA	94
■ OMBRA	98
■ KIRO 40 B/Q	102
■ LIBERTY P/S-ECLISSE	106
■ EUROPA 4000	110
■ STAR BOX	112
■ VERONA	116

CAPPOTTINE / BASKET AWNINGS / STORES CORBEILLE

■ CAPPOTTINE	118
■ ASIA	124
■ ECO TUNNEL	126

VETRATE/ / GLASS WINDOWS / FENÊTRES EN VERRE

■ SCREENS	128
■ VETRATA SCORREVOLE	132
■ SCREENS GLASS	126

ACCESSORI ED ELETTRONICA / ACCESSORIES AND ELECTRONICS / ACCESSOIRES ET ELECTRONIQUE

■ CALOTTE	140
■ ASTE DI MANOVRA	141
■ TUBI AVVOLGITORI	142
■ MOLLE	142
■ BRACCI	144
■ MODULO ORDINE	147

SIMBOLOGIA / SIMBOLOGY / SYMBOLOGIE

Cf = Confezione / Packaging / Confection

Pz = Pezzo / piece / pièce

Cp = coppia / pair/ paire

Ml = Metro lineare / linear meter / mètre linéaire

Bb = Bobina / bobin / bobine



Argano
Gearbox
Treuil



Kit Bracci incrociati
Crossing arms kit
Kit bras croisés



Tubo Ø 60
Tube Ø 60
Tube Ø 60



Molla
Spring
Ressorts



Motore
Motors
Moteurs



Tubo Ø 70
Tube Ø 70
Tube Ø 70



Tettino
Canopy
Auvent



Corda
Rope
Corde



Tubo Ø 80
Tube Ø 80
Tube Ø 80

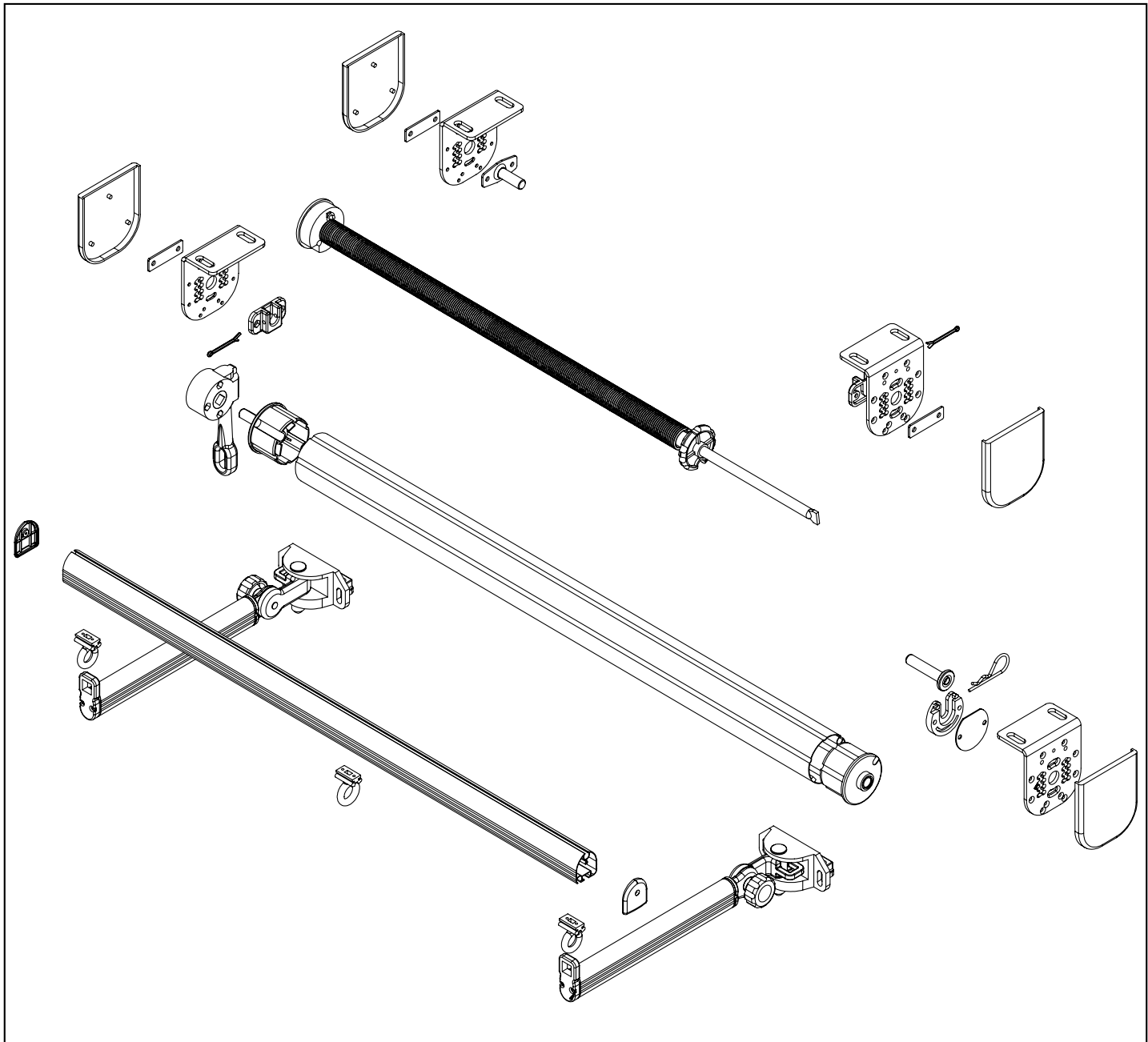

Colori di serie / Standard color / Couleurs standard



Ral
Bianco
9010

Ral
Bronzo

Ral
Avorio
1013

Ral
Marrone
8017



Ral
Grigio
7035

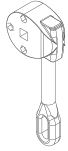
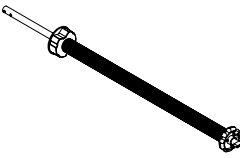
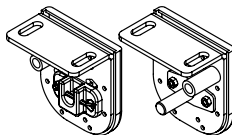
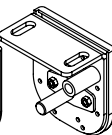
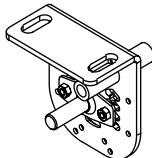
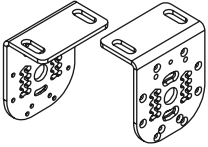
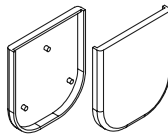
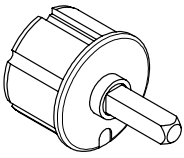
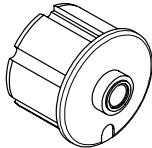
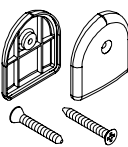
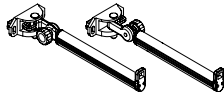

Ral
Antracite

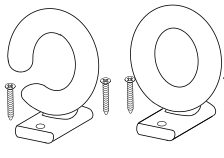
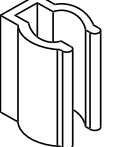
Altri colori / Another colors / Autres couleurs +20%

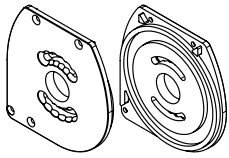
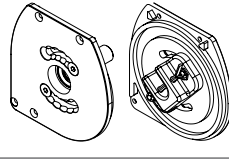
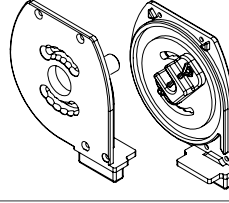
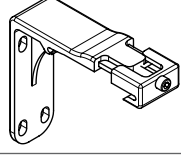
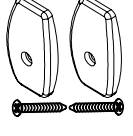
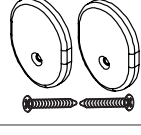
Disegno Figure Design	Descrizione Description Description	Informazioni Informations Information	Codice Article Code Code Article	U.M. Unit	Prezzo unitario Unit price Prix unitaire	Conf. std. Std. pack Cf. std
	Arganello riduttore Awning gearbox Treuil		ARG7:1A ARG 3,5:1AS12	Pz		25
	Molla assemblata ø 60 Spring assembled ø 60 Ressort assemblé ø.60	Cm 35 Cm 50 Cm 70 Cm 90 Cm 120 Cm 140	MOLLA35 MOLLA50 MOLLA70 MOLLA90 MOLLA120 MOLLA140	Pz		10
	Staffe tnr p/s con cuffie Brackets tnr wall/ceiling with cover Supports tnr mur/plafond avec bouchons		TNRS0A003	Cp		50
	Staffe tnr p/s senza cuffie Brackets tnr wall/ceiling without cover Supports tnr mur/plafond sans bouchons		TNRS0A004			
	Staffa tnr p/s accoppiata Bracket tnr wall/ceiling compound Support tnr mur/plafond uni		TNRS0A005	Pz		50
	Staffa tnr p/s nuda Bracket tnr wall/ceiling simple Support tnr mur/plafond simple		TNRS0A006	Cp		50
	Cuffie per staffe tnr Bushing for pivot arm tnr Bouchons pour supports tnr		C0A002	Cp		100
	Tappo ø 60 perno quadro 13x40 Plug ø 60 with square pin 13x40 Embout ø axe carré 13x40		TAPPQ60-13x40	Pz		120
	Tappo ø 60 con foro ø 14 Plug ø 60 with hole ø 14 Embout ø 60 avec trou ø 14		TAPF60	Pz		150
	Tappo terminale tnr in nylon con viti Caps for terminal profile tnr with screw Bouchons barre de charge tnr en nylon avec vis	viti Zinc. viti Inox	TNRT0A006 TNRT0A02	Cp		50
	Braccetti tnr Arms tnr Bras tnr	Ringhiera Muro	TNR0A017 TNR0A018	Cp		15

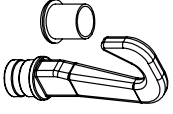
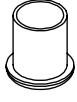
Disegno Figure Dessign	Descrizione Description Description	Informazioni Informations Information	Codice Article Code Code Article	U.M. Unit Unit price	Prezzo unitario Unit price Prix unitaire	Conf. std. Std. pack Cf. std
	Braccetti snodati con gancio aperto Articulated arms with open hook Bras articulés avec crochet ouvert\	Ringhiera	NAPO-045	CP		25
	Braccetti snodati con gancio aperto Articulated arms with open hook Bras articulés avec crochet ouvert\	Muro	NAPO-046	CP		25
	Braccetto fissi con gancio aperto Arms fixed with open hook Bras fixes avec crochet	Ringhiera Muro	NAPO 030 NAPO-035	Cp		250
	Occhiolo terminale tnr/tm in Nylon con grani zincati/inox Eyelit open open tnr/tm nylon With zinc/ steel screws Goulotte barre de charge tnr/tm en nylon avec vis	Zincato aperto Zincato chiuso Inox aperto Inox chiuso	TMOCCNYLONA TMOCCNYLON1A TMOCCNYLON2A TMOCCNYLON3A	Pz		100 50 100 50
	Occhiolo terminale tnr/tm in alluminio con grani zincati/inox Eyelit open open tnr/tm alluminio With zinc/ steel screws Goulotte barre de charge tnr/tm en aluminium avec vis	Zincato aperto Zincato chiuso Inox aperto Inox chiuso	TMOCCALLA TMOCCALL1A TMOCCALL2A TMOCCALL3A	Pz		100 50 100 50
	Piastrina omega in nylon Nylon omega Plaque oméga en nylon		TNRM-045	Pz		100
	PIASTRINA CON PERNO Senza bulloni e dadi Without bolts and nuts Sans boulons et écrous Con bulloni M6x16 e dadi M6 With bolts M6x16 and nuts M6 Avec boulons M6x16 et écrous M6	14x40 14x75	PCP00001 PCP00002	Pz		100
	Piastrina in nylon con perno estraibile Plate nylon with removable pin Plaque en nylon avec axe extraible		PES00005	Pz		100
	Supporto asta Bushing for pivot arm tnr/tm Support manivelle	Mm 20 Mm 14	TMSUP.ASTA1A TMSUP.ASTA2A	Pz	1,30 1,11	100
	Supporti soffitto cassonetto tcn Support box for ceiling tcn Supports plafond pour coffre tcn		TCN0A0004	Cp	6,64	100

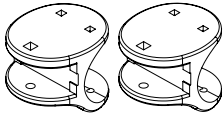
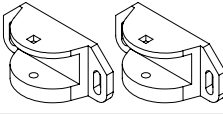
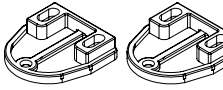
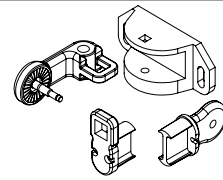
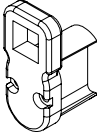
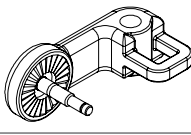
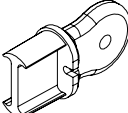
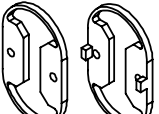
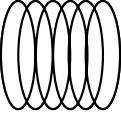
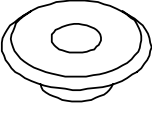
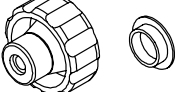
Disegno Figure Dessign	Descrizione Description Description	Informazioni Informations Information	Codice Article Code Code Article	U.M. Unit Unit	Prezzo unitario Unit price Prix unitaire	Conf. std. Std. pack Cf. std
	Tappi cassonetto tcn Caps for box tcn Bouchons coffre tcn		TCN0A0002	Cp		100
	Tappi cassonetto tcn a molla Caps box tcn spring Bouchons coffre tcn avec ressort		TCN0A0006	Cp		50
TAPPI CASSONETTO TCN A MOLLA / CAPS BOX TCN SPRING / BOUCHONS COFFRE TCN AVEC RESSORT						
	Con innesto guida tmt With attachment tmt Avec attache guide tmt		TCN0A007			
	Con innesto guida tms With attachment tms Avec attache guide tms		TCN0A008	Cp		50
TAPPI CASSONETTO TCN AD ARGANELLO / CAPS BOX TCN AWNING / BOUCHONS COFFRE TCN AVEC TREUIL						
	Con innesto guida tmt With attachment tmt Avec attache guide tmt		TCN0A009			
	Con innesto guida tms With attachment tms Avec attache guide tms		TCN0A010	Cp		50
	Supporto parete cassonetto tcn Support box for wall tcn Support mur pour coffre tcn		TCN0A0005	Pz		100
	Tappi terminale tcn con viti Plug for terminal profile tcn with screws Bouchons barre de charge tcn		TCN0A0003	Cp		100
	Tappi terminale tcnBR con viti Plug for terminal profile tcn with screws Bouchons barre de charge tcn		TNRM-055	Cp		100
	Asta per tm/tnr Crank handle for tm/tnr Manivelle pour tm/tnr	Cm 140	TM0A006	Pz		25
	Kit asta per tenda a molla completo Kit crank handle for awning spring Kit manivelle pour store avec ressort complet		KIT.ASTA	Pz		100
	Tappo per asta ø 20 Cap for crank handle ø 20 Bouchon pour manivelle ø 20		TAP.ASTA	Pz		100
	Gancio per asta ø 20 Hook for crank handle ø 20 Crochet pour manivelle ø 20		GAN.ASTA	Pz		100
	Tappo terminale tm in nylon Plug for terminal profisle tm Bouchon barre de charge tm en nylon	Ø 30	TAPTM30A			
		Ø 35	TAPTM35A	Pz		100

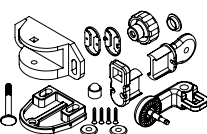
Disegno Figure Dessign	Descrizione Description Description	Informazioni Informations Information	Codice Article Code Code Article	U.M. Unit Unit	Prezzo unitario Unit price Prix unitaire	Conf. std. Std. pack Cf. std
	Supporto a ringhiera tonda Round railing support Support de garde-corps rond	Ø 50 Ø 60	TNRM047 TNRM054	Cp		50
	Supporto a muro per braccetto tnr Support for arms for wall railing tnr Support mur pour bras tnr		TNRT0A007	Cp		50
	Piastrine a ringhiera per braccetto tnr Plates for railing of arm tnr allum. Plaquettes balustrade pour bras tnr		TNRT0A008	Cp		50
	Kit fusioni braccetto tnr Kit mergers for arm tnr Kit bras tnr		TNRT0A009	Pz		50
	Puntale braccetto tnr Tip of arm tnr allum. Pointe bras tnr		TNRT0A013	Pz		100
	Snodo braccetto tnr Joint for arm tnr allum. Articulation bras tnr		TNRT0A015	Pz		100
	Corona braccetto tnr Crown arm tnr allum. Couronne bras tnr		TNRT0A017	Pz		100
	Guarnizioni braccetto tnr Seals arms tnr Joint bras tnr		TNR0A010	Cp		100
	Molla per braccetto tnr Spring for arm tnr Ressort pour bras tnr		MOLLA-BR	Pz		100
	Boccola snodo braccetto tnr/tm Bushing for pivot arm tnr/tm Bague bras tnr/tm		TNRM-001	Pz		100
	Manopola con tappo Knob with bush brass with cap Bouton avec bouchon		MAN0D001	Pz		100
	Tappo manopola Control knob cap Bouchon		MAN0D002	Pz		100
	Clips braccetto Clips arm Clips bras		CLIPS-BR	Pz		100
	Kit braccetto tnr completo di profili Kit arm full profile tnr allum. Kit bras complet de profils		TNRT0A019	Cp		50

Disegno Figure Dessign	Descrizione Description Description	Informazioni Informations Information	Codice Article Code Code Article	U.M. Unit	Prezzo unitario Unit price Prix unitaire	Conf. std. Std. pack Cf. std
	Supporti tm p/s completi Kit support tm wall/ceiling Supports tm mur/plafond Complets		TM0A001	Cp		25
	Supporto femmina tm p/s Support female tm wall/ceiling Support tm mur/plafond		TM0A003	Pz		25
	Supporto maschio tm p/s Support male tm wall/ceiling Support tm mur/plafond Avec axe		TM0A004	Pz		25
	Supporto tm p/s accoppiata Coupled support tm wall/ceiling Support tm mur/plafond uni		TM0A002	Pz		25
	Staffa universale tm con asole Universal bracket tm with slots allum. Support univ. Tm avec trous		TM0A015	Pz		25
	Attacco a terra pvc Ground attack open pvc Crochet au sol en pvc		TNR0A036	Pz		100
	Puntale aperto in alluminio Open toe at aluminium Crochet en aluminium		TNRT0A028	Pz		100
	Occhiolo chiuso in nylon Eyelet closed nylon Crochet en nylon		TNR0A027	Pz		100
	Attacco a terra chiuso in pvc Coupler to the ground pvc Attaque au sol fermé en pvc		TMTERRA	Pz		100
	Coppiglia dritta 4 x 50 Cotter pin 4 x 50 Goupille 8 x50		COPPIGLIA	Pz		100
	Innesto guida tmt With attachment tmt Insert pour guide tmt		TNR0A020	Cp		100
	Innesto guida tms With attachment tms Insert pour guide tms		TMS0A021	Cp		100

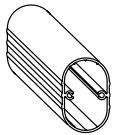
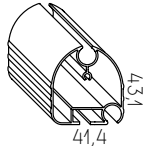
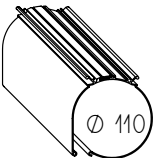
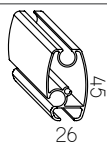
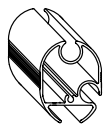
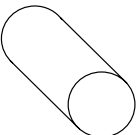
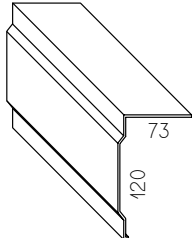
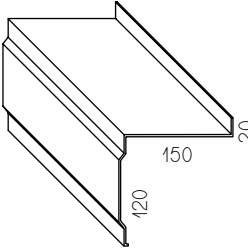
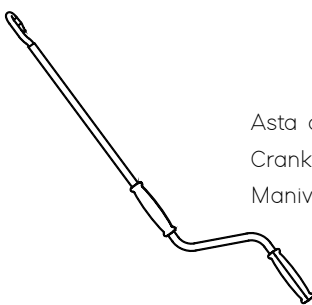
Disegno Figure Dessign	Descrizione Description Description	Informazioni Informations Information	Codice Article Code Code Article	U.M. Unit	Prezzo unitario Unit price Prix unitaire	Conf. std. Std. pack Cf. std
	Profilo per braccetto tnr Profile for arm tnr Profil pour bras tnr	Cm 560 535gr/ml	TNR5,6	Pz		10
	Terminale tnr 852 Terminal profile tnr 852 Barre de charge tnr 852	Cm 300 Cm 400 Cm 700 624gr/ml	TNR3A001 TNR4A001 TNR7A001	Pz		10
	Cassonetto di protezione tcn Box of protection tcn Coffre tcn	Cm 300 Cm 700 1884gr/ml	TCNCASS3A TCNCASS7A	Pz		10
	Terminale tcn Terminal profile tcn Barre de charge tcn	Cm 300 Cm 700 582gr/ml	TCNTER3A TCNTER7A	Pz		10
	Terminale tcnBR Terminal profile tnr Barre de charge tnr	Cm 700 624gr/ml	TNCBRI7A			
	Profilo Ø 20 per asta di manovra Profile Ø 20 for maneuver rod Profil Ø 20 pour tige de manouvre	Cm 300 Cm 700 327gr/ml	TM3A014 TM7A014	Pz		10
	Tettino di protezione a soffitto Tm/tnr/tmt Canopy of protection Tm/tnr/tmt for celing Auvent plafond pour tm/tnr/tmt	Cm 300 Cm 400 Cm 700 1134gr/ml	TM3A018 TM4A018 TM7A018	Pz		10
	Tettino di protezione a parete Tm/tnr/tmt Canopy of protection Tm/tnr/tmt for wall Auvent mur pour tm/tnr/tmt	Cm 400 Cm 500 Cm 600 Cm 700 1675gr/ml	TMT4A015 TMT5A015 TMT6A015 TMT7A015	Pz		10
	Asta di manovra verniciata Crank handle Manivelle laquée	Cm 100 Cm 120 Cm 150 Cm 180 Cm 200 Cm 220 Cm 250 Cm 300	AST0A100 AST0A120 AST0A150 AST0A180 AST0A200 AST0A220 AST0A250 AST0A300	Pz		10

Note

A large rectangular area with horizontal dotted lines, intended for writing notes.

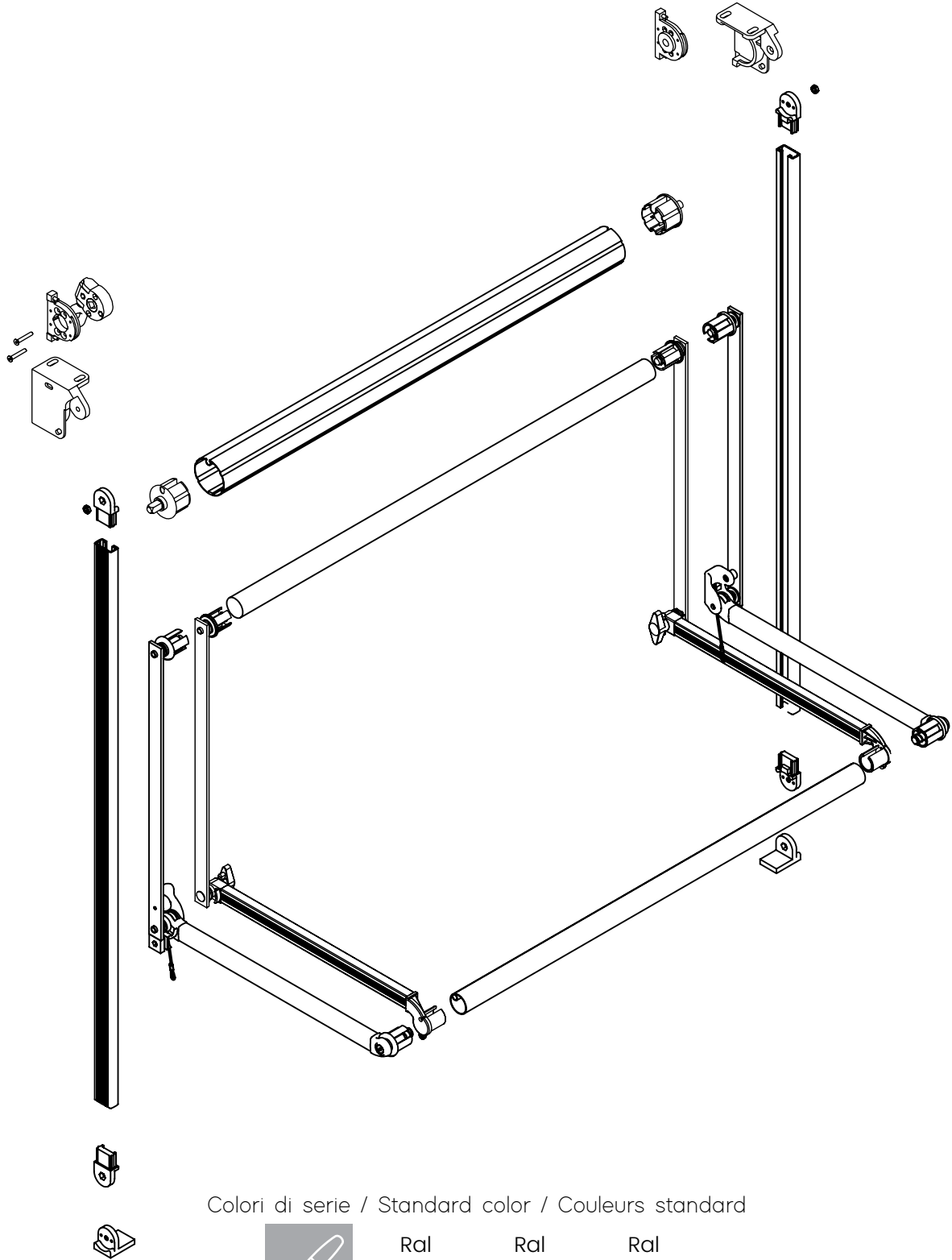

Colori di serie / Standard color / Couleurs standard



Ral
Bianco
9010

Ral
Avorio
1013

Ral
Grigio
7035

Ral
Bronzo

Ral
Oro

Altri colori / Another colors / Autres couleurs +20%

Disegno Figure Dessign	Descrizione Description Description	Informazioni Informations Information	Codice Article Code Code Article	U.M. Unit Unit	Prezzo unitario Unit price Prix unitaire	Conf. std. Std. pack Cf. std
	Arganello riduttore 4,7:1 gambo corto TMS Awning gearbox 4,7:1 Treuil 4,7:1 Arganello riduttore 7:1 TMS BR Awning gearbox 7:1 Treuil 7:1		ARG-4,7:1A ARG7:1A			Pz 25
	Supporti in alluminio con boccole Ceiling supports at allum. Kit with bushings Supports plafond en aluminium avec bagues		TMS0A003	Cp		20
	Tappo ø 60 con perno quadro 13x25 TMS Plug with square pin 13x25 ø 60 Embout ø 60 avec axe carré 13x25		TAPPQ60-13X25	Pz		80
	Tappo ø 60 con perno quadro 13x40 TMS BR Plug with square pin 13x40 ø 60 Embout ø 60 avec axe carré 13x40		TAPPQ60-13X40	Pz		80
	Tappo ø 60 con perno tondo 14x20 Plug with round pin 14x20 ø 60 Embout ø 60 avec axe rond 14x20		TAPPT60	Pz		100
	Calotta ø 40 frangivento tms Caps d.40 For windbreak tms Embout ø 40 brise-vent tms		TAPS40A	Pz		25
	Calotta scorrevole ø 40 tms Caps sliding ø 40 tms Embout coulissant ø 40 tms		TAPSCO40A	Cp		25
	Piedini e attacchi per guida Legs and attacks for guide Pieds et attaches pour guide		TMS0A002	Cf		25
	Braccetti tms Awning arms tms Bras tms		TMS0A001	Cp		6
	Braccetti tms a molla Awning arms with spring tms Bras tms avec ressort		TMS0A005	Cp		6
	Linguetta per guida tms Tap for guide tms Languette pour guide		TMS0A020	Cp		6
	Scorrevole per guida tms Sliding for guide tms Coulisse pour guide tms Scorrevole per guida tms a molla Sliding for guide a spring tms Coulisse pour guide tms avec ressort		TMSSCORA TMSSCO-1A			Cp 50

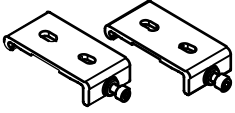
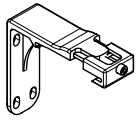
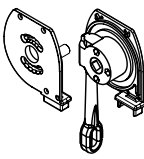
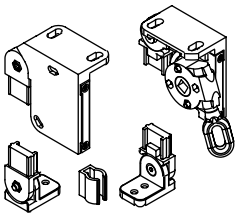
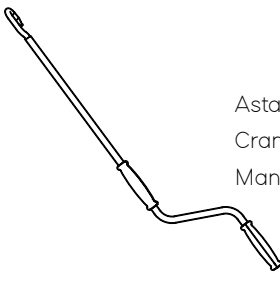
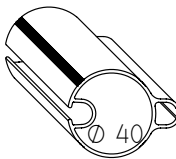
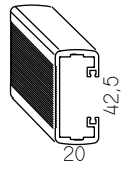
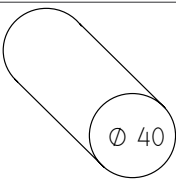
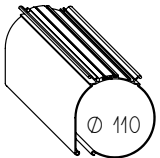
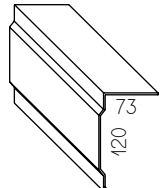
Disegno Figure Dessign	Descrizione Description Description	Informazioni Informations Information	Codice Article Code Code Article	U.M. Unit Unit	Prezzo unitario Unit price Prix unitaire	Conf. std. Std. pack Cf. std
	Supporti soffitto cassonetto Support box for ceiling tcn Supports plafond pour coffre tcn		TCN0A0004	Pz		100
	Supporto parete cassonetto Support box for wall Support mur pour coffre tcn		TCN0A0005	Pz		100
	Tappi cassonetto ad arganello 4,7:1 Gambo lungo 4.7: 1 gear box caps with long stem 4.7: 1 capuchons de boîte de vitesses à longue tige		TCN0A010	Cp		50
	Kit tms completo di arganello Tms kit complete with winch Kit tms complet avec treuil		KIT-TMS-2	Pz		10
	Asta di manovra verniciata Crank handle Manivelle laquée	Cm 100 AST0A100 Cm 120 AST0A120 Cm 150 AST0A150 Cm 180 AST0A180 Cm 200 AST0A200 Cm 220 AST0A220 Cm 250 AST0A250 Cm 300 AST0A300		Pz		10
	Terminale tms d.40 Terminal profile tms d.40 Barre de charge tms ø 40	Cm 400 TMS4A010 Cm 500 TMS5A010 Cm 600 TMS6A010 Cm 700 TMS7A010 725gr/ml		Pz		10
	Guida tms Guide allum. Tms Guide tms	Cm 700 TMSA700 610gr/ml		Pz		10
	Frangivento tms ø 40 Windbreak tms ø 40 Brise-vent tms ø 40	Cm 400 TMS4A003 Cm 500 TMS5A003 Cm 600 TMS6A003 Cm 700 TMS7A003 515gr/ml		Pz		10
	Cassonetto di protezione Box of protection Coffre	Cm 300 TCNCASS3A Cm 700 TCNCASS7A 1884gr/ml		Pz		10
	Tettino di protezione a soffitto Canopy of protection for celing Auvent plafond pour	Cm 300 TM3A018 Cm 400 TM4A018 Cm 700 TM7A018 1134gr/ml		Pz		10

Note

A large rectangular area with horizontal dotted lines, intended for writing notes.

TMS SILVER



60

70

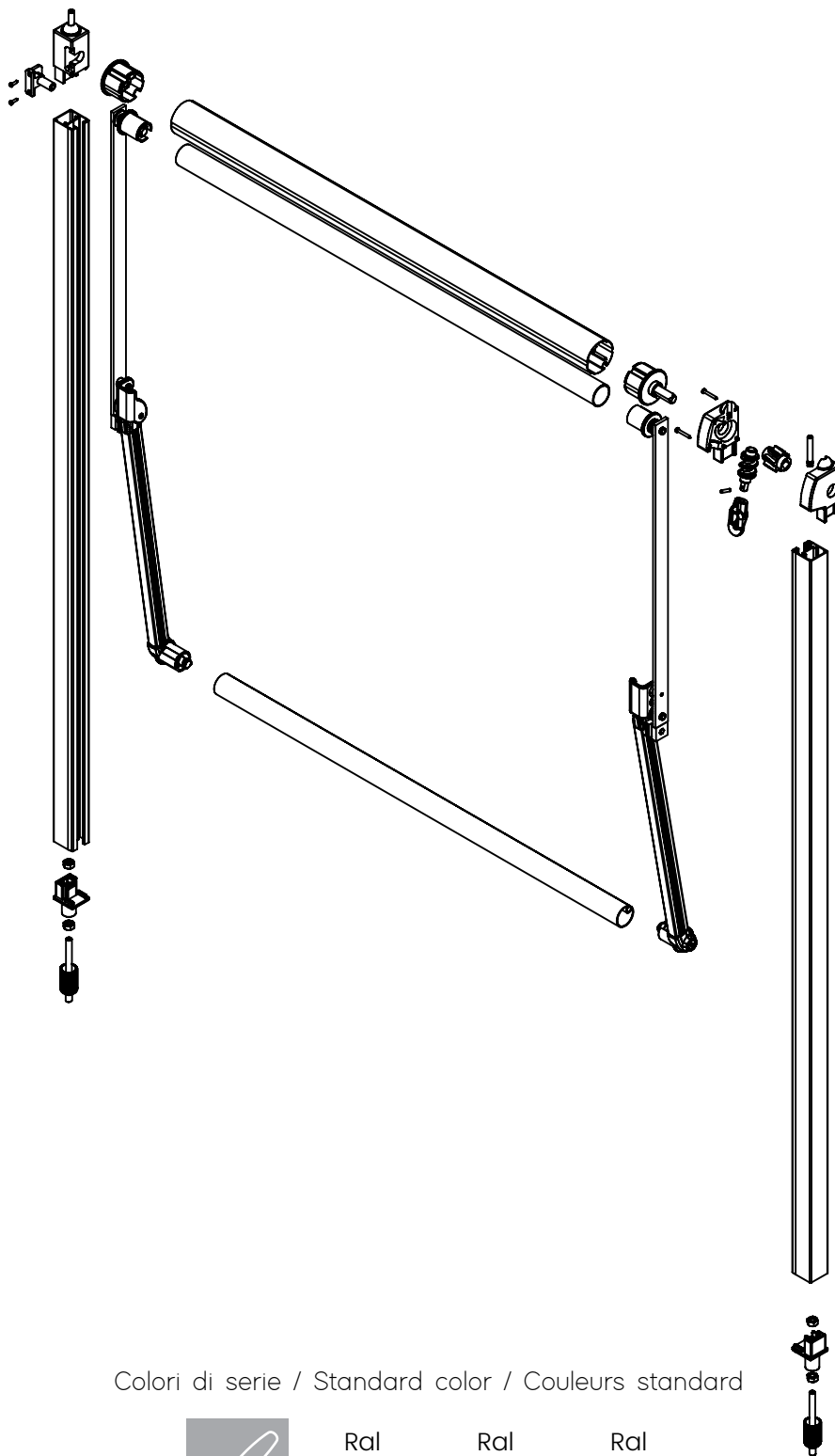

Colori di serie / Standard color / Couleurs standard



Ral
Bianco
9010

Ral
Avorio
1013

Ral
Grigio
7035

Ral
Bronzo

Ral
Oro

Altri colori / Another colors / Autres couleurs +20%

Disegno Figure Design	Descrizione Description Description	Informazioni Informations Information	Codice Article Code Code Article	U.M. Unit Unit	Prezzo unitario Unit price Prix unitaire	Conf. std. Std. pack Cf. std
	Arganello tms silver Awning tms silver Treuil tms silver		SLVR-015	Pz		10
	Innesto superiore guida dx Right upholstery engagement Guide supérieur à droit Innesto superiore guida sx Left upholstery engagement Guide supérieur à gauche		SLVR-013 SLVR-018	Pz		10
	Tappo ø 60 con perno quadro 13x40 Plug with square pin 13x40 ø 60 Embout ø 60 avec axe carré 13x40		TAPPQ60-13x25 TAPPQ60-13x40	Pz		80
	Tappo ø 60 con foro ø 14 Plug ø 60 with hole ø 14 Embout ø 60 avec axe rond 14x20		TAPF60	Pz		100
	Calotta ø 40 frangivento tms Caps d.40 For windbreak tms Embout ø 40 brise-vent tms		TAPS40A	Pz		25
	Calotta scorrevole ø 40 tms Caps sliding ø 40 tms Embout coulissant ø 40 tms		TAPSCO40A	Cp		25
	Piedino regolabile tms silver Adjustable foot tms silver Pied tms silver réglable		SLVR-016	Pz		20
	Braccetti tms silver Arms tms silver Bras tms Braccetti tms silver a molla Arms with spring tms silver Bras tms avec ressort		SLVR-030 SLVR-029	Cp		6
	Linguetta per guida tms Tap for guide tms Languette pour guide		TMS0A020	Cp		6
	Scorrevole per guida tms Sliding for guide tms Coulisse pour guide tms Scorrevole per guida tms a molla Sliding for guide a spring tms Coulisse pour guide tms avec ressort		TMSSCOR TMSSCOR-1A	Cp		50
	Rondella concava Concave washer Rondelle concave		SLVR-020	Pz		10

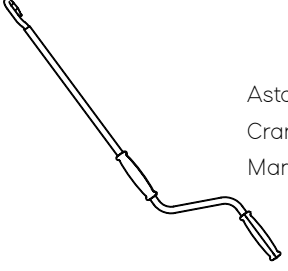
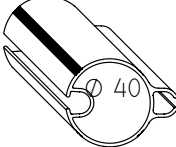
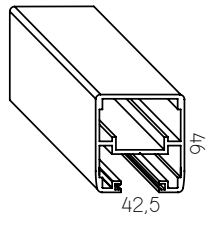
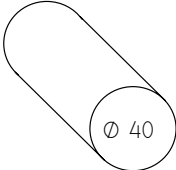
Disegno Figure Dessign	Descrizione Description Description	Informazioni Informations Information	Codice Article Code Code Article	U.M. Unit Unit price	Prezzo unitario Unit price Prix unitaire	Conf. std. Std. pack Cf. std
	Asta di manovra verniciata Crank handle Manivelle	Cm 100	AST0A100	Pz		10
		Cm 120	AST0A120			
		Cm 150	AST0A150			
		Cm 180	AST0A180			
		Cm 200	AST0A200			
		Cm 220	AST0A220			
		Cm 250	AST0A250			
		Cm 300	AST0A300			
	Terminale tms ø 40 Terminal profile tms ø 40 Barre de charge tms ø 40	Cm 400	TMS4A010	Pz		10
		Cm 500	TMS5A010			
		Cm 600	TMS6A010			
		Cm 700	TMS7A010			
		725gr/ml				
	Guida tms silver Guide allum. Tms silver Guide tms silver	Cm 700	SLVR7A001	Pz		10
		1179gr/ml				
	Frangivento tms ø 40 Windbreak tms ø 40 Brise-vent tms/gold ø 40	Cm 400	TMS4A003	Pz		10
		Cm 500	TMS5A003			
		Cm 600	TMS6A003			
		Cm 700	TMS7A003			
		515gr/ml				

Note

A large rectangular area with horizontal dotted lines, intended for writing notes.

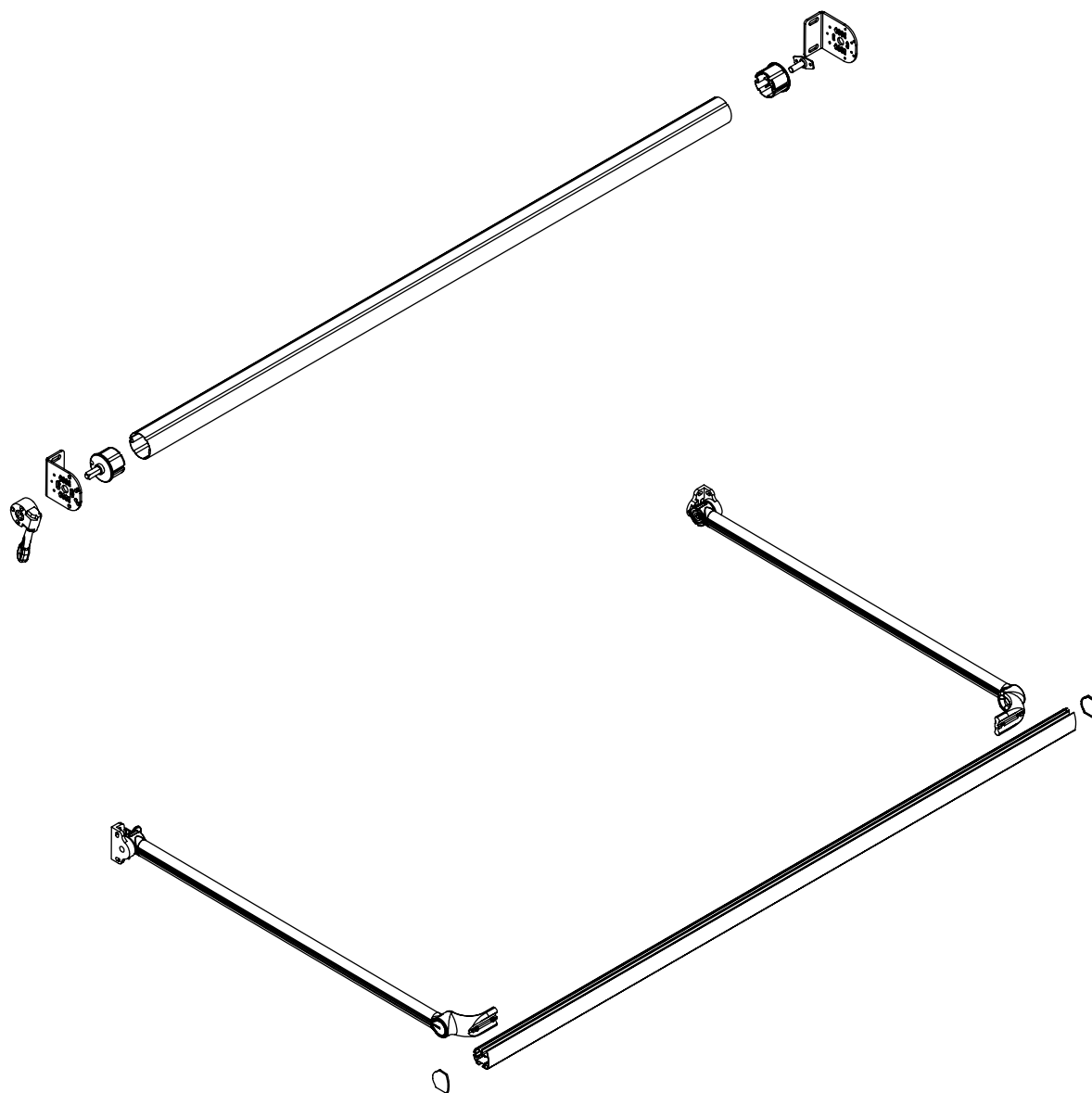

Colori di serie / Standard color / Couleurs standard



Ral
Bianco
9010

Ral
Avorio
1013

Ral
Grigio
7035

Ral
Marrone
8017

Ral
Antracite

Altri colori / Another colors / Autres couleurs +20%

Disegno Figure Design	Descrizione Description Description	Informazioni Informations Information	Codice Article Code Code Article	U.M. Unit Unit price	Prezzo unitario Unit price Prix unitaire	Conf. std. Std. pack Cf. std
	Arganello 11:1 Awning gearbox 11:1 Treuil 11:1		ARG11A	Pz		25
	Staffa tnr p/s nuda Bracket tnr wall/ceiling simple Support tnr mur/plafond simple		TNRS0A006	Cp		50
	Cuffie per staffe tnr Bushing for pivot arm tnr Bouchons pour supports tnr		COA002	Cp		100
	Contropiastrina Counterplate Contre-plaque		PCF0003	Pz		100
	Tappo ø 60 con perno quadro 13x25 Plug with square pin 13x25 ø 60 Embout ø 60 avec ax carré 13x40		TAPPQ60-13x25	Pz		80
	Tappo ø 60 con foro ø 14 Plug ø 60 with hole ø 14 Embout ø 60 avec trou ø 40		TAPF60	Pz		100
	Piastrina in nylon con perno estraibile Plate nylon with removable pin Plaquette en nylon avec axe extraible		PES-0005	Pz		100
	Tappi per terminale 30600 con viti Plug for terminal profile model 30600 Bouchons barre de charge 30600 avec vis		KIR0A025	Cp		100
		Cm 80 Cm 100 Cm 120 Cm 140 Cm 160	TMB0A080 TMB0A100 TMB0A120 TMB0A140 TMB0A160	Cp		5
	Terminale 30600 Terminal profile 30600 Barre de charge 30600	Cm 400 Cm 500 Cm 600 Cm 700 1005gr/ml	KIR4A001 KIR5A001 KIR6A001 KIR7A001	Pz		10
	Tappi cassonetto ad arganello 4,7:1 Gambo lungo 4.7: 1 gear box caps with long stem 4.7: 1 capuchons de boîte de vitesses à longue tige		TCN0A010	Cp		50
	Supporto parete cassonetto Support box for wall Support mur pour coffre tcn		TCN0A0005	Pz		100
	Cassonetto di protezione TMS Box of protection tms Boîte de protection TMS	Cm 300 Cm 700 1884gr/ml	TCNCASS3A TCNCASS7A	Pz		10

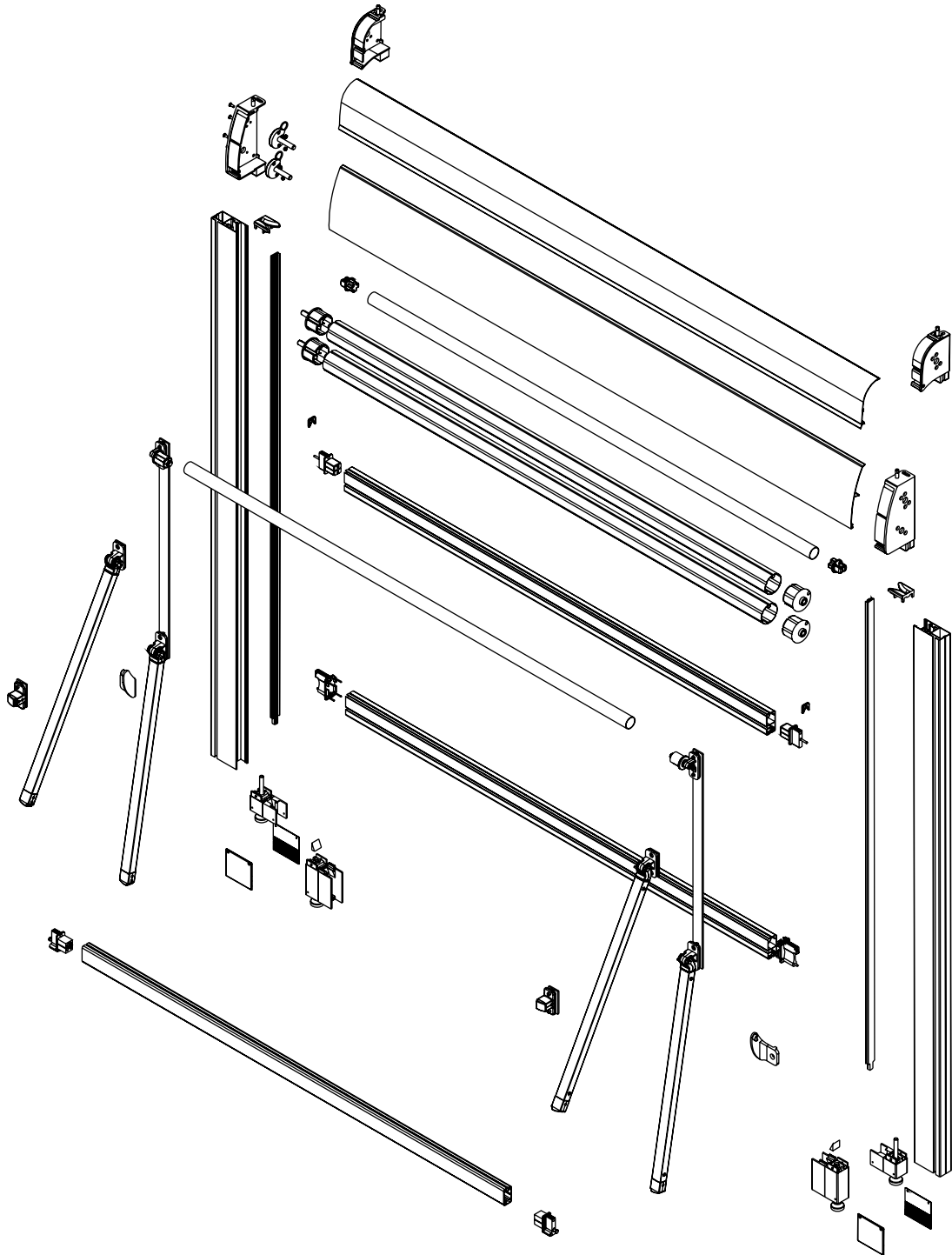

Colori di serie / Standard color / Couleurs standard





Ral
Bianco
9010

Ral
Avorio
1013

Ral
Bronzo

Ral
Grigio
7035

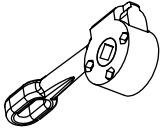
Altri colori / Another colors / Autres couleurs +20%

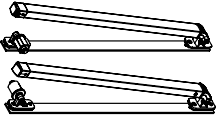
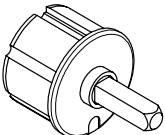
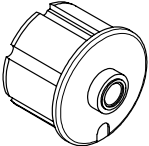
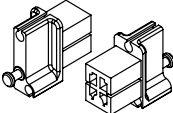
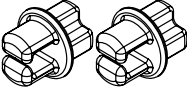
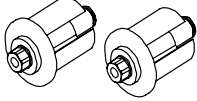
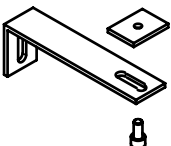
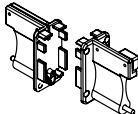
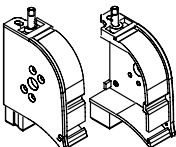
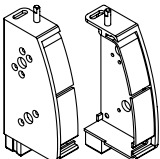
Disegno Figure Design	Descrizione Description Description	Codice Article Code Code Article	U.M. Unit	Prezzo unitario Unit price Prix unitaire	Conf. std. Std. pack Cf. std
	Arganello 7:1 Awning gearbox 7:1 Treuil 7:1	ARG7:1A	Pz		25
	Braccetti p-gold Arms p-gold Bras gold	Cm 85 GOBRA0085A Cm 95 GOBRA0095A	Cp		5
	Braccetti scorrevoli p-gold Sliding arms p-gold Bras coulissants p-gold	Cm 73 GOBRA0073S-A Cm 85 GOBRA0085S-A Cm 95 GOBRA0095S-A	Cp		5
	Tappo ø 70 con perno quadro 13x25 Plug with square pin 13x25 ø 70 Embout ø 70 avec axe carré 13x25	TAPPQ70-13x25	Pz		80
	Tappo ø 70 con foro ø 14 Plug ø 70 with hole ø 14 Embout ø 70 avec trou ø 14	TAPF70	Pz		200
	Tappo terminale estivo p-gold Plug terminal profile summer p-gold Bouchons barre de charge gold	GOLD-023	Cp		10
	Calotta frangivento invernale Windbreak cap winter Embout brise-vent hivernal	GOLD0001A	Cp		10
	Calotta frangivento estiva Summer windbreak cap Embout brise-vent estival	GOLD0003A	Cp		10
	Staffa a "L" completa di piastrina bullone e dado "L" bracket complete with bolt plate and nut Support à "L" pour gold caomplet de plaquette, boulon et écrou	Cm 20 GOLD0A004 Cm 15 GOLD0A005 Cm 10 GOLD0A006	Pz		5
	Tappo terminale invernale zip Plug for winter terminal zip Bouchon d'hiver zip	GOLD-138	Cp		10
	Tappi carter p-gold 1 rullo 1-roll p-gold carter caps Casquettes 1 rouleau P-Gold Carteru	GOLD-129	Cp		10
	Tappi carter p-gold 2 rulli Carter caps p-gold 2 rollers Carter Caps P-Gold 2 rouleaux	GOLD-228	CP		10

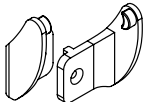
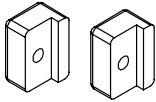
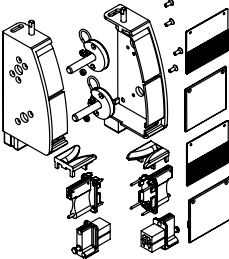
Disegno Figure Dessign	Descrizione Description Description	Informazioni Informations Information	Codice Article Code Code Article	U.M. Unit Unit	Prezzo unitario Unit price Prix unitaire	Conf. std. Std. pack Cf. std
	Guarnizione per carter Seal for carter Joint pour carter		GOLD001	MI	€	50
	Fermo per braccetto scorrevole completo di piastrina Latch gold for sliding plate Arrêt pour bras coulissant		GOLD0A008	Cp		10
	Tacchetti per bloccaggio frangivento Studs for locking windbreak gold Clou pour blocage brise-vent		GOLD-M3	Pz		20
	Spazzolino mm. 5X9 per guida Brush 6x9 Brosse mm. 5X9 pour guide		ZANZ008	MI		650
	Kit accessori Gold 1 rullo Gold zip 1 roller accessory kit Gold zip 1 kit d'accessoires de rouleau		KIT.GOLDZIP1R.A	Pz		6
	Kit accessori Gold 2 rulli Gold zip 2 roller accessory kit Gold zip 2 kit d'accessoires de rouleau		KIT.GOLDZIP2R.A	Pz		6
	Piedini p-gold zip P-gold zip feet Pieds zip P-gold		GOLD-218	Cp		6
	Piedini p-gold manuali Manual p-gold feet Gold zip 2 kit d'accessoires de rouleau		GOLD-301	Cp		6
	Kit Gold aggancio automatico Kit Gold automatic coupling Kit Gold accouplement automatique		KIT.GOLD.AUT	Pz		6
	Kit Gold aggancio automatico Manual coupling Gold kit Attelage manuel Kit Gold		KIT.GOLD.MAN	Pz		6

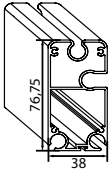
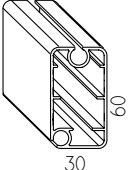
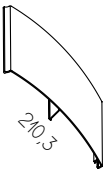
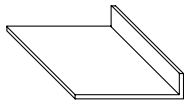
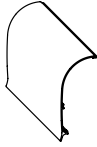
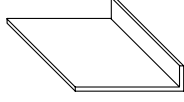
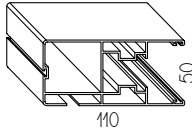
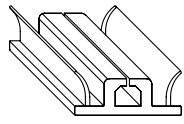
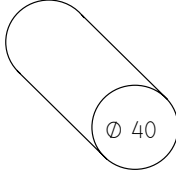
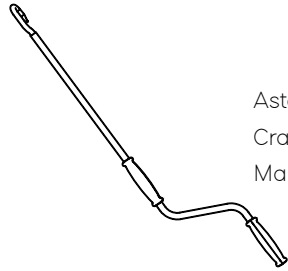
Disegno Figure Design	Descrizione Description Description	Informazioni Informations Information	Codice Article Code Code Article	U.M. Unit Unit	Prezzo unitario Unit price Prix unitaire	Conf. std. Std. pack Cf. std
	Terminale omega invernale con zip	Cm 400	TCL4A002			
	Winter omega terminal with zip	Cm 500	TCL5A002	Pz		10
	Omega terminal d'hiver avec zip	Cm 700	TCL7A002			
		1819gr/ml				
	Terminale p-gold estate inverno senza zip	Cm 700	TCLB7A001	Pz		10
Terminal p-gold summer winter without zip	1045gr/ml					
Barre de charge p-gold						
	Carter p-gold 2 rulli	Cm 400	KITCASSTA004	Pz		10
	Carter p-gold 2 rollers	Cm 600	KITCASSTA006			
	Carter p-gold 2 rouleaux	1463gr/ml				
	Carter interno p-gold 2 rulli	Cm 600	KITCASSIN6A	Pz		10
	Internal casing p-gold 2 rollers					
	Boîtier interne p-or 2 rouleaux					
	Carter p-gold 1 rullo	Cm 400	CART1R4A	Pz		10
	Carter p-gold 1 roller	Cm 600	CART1R6A			
	Carter p-gold 1 rouleau	1275gr/ml				
	Carter interno p-gold 1 rulli	Cm 600	CARTINT6A	Pz		10
	Internal casing p-gold 1 roller					
	Boîtier interne p-or 1 rouleau					
	Guida p-gold	Cm 600	P-G6A			10
	Guide p-gold			Pz		
	Guide p-gold	Cm 700	P-G7A			
		2043gr/ml				
	Slim per guida	Cm 400				10
	Slim for guide	Cm 500	VA113	Pz		
	Slim for guide	Cm 600				
		Cm 700				
	Frangivento p-gold ø 40	Cm 400	TMS4A003			10
	Windbreak p-gold ø 40	Cm 500	TMS5A003	Pz		
	Brise-vent tms/gold ø 40	Cm 600	TMS6A003			
		Cm 700	TMS7A003			
		515gr/ml				
	Asta di manovra verniciata	Cm 100	AST0A100			10
	Crank handle	Cm 120	AST0A120			
	Manivelle	Cm 150	AST0A150			
		Cm 180	AST0A180			
		Cm 200	AST0A200	Pz		
		Cm 220	AST0A220			
		Cm 250	AST0A250			
	Cm 300	AST0A300				

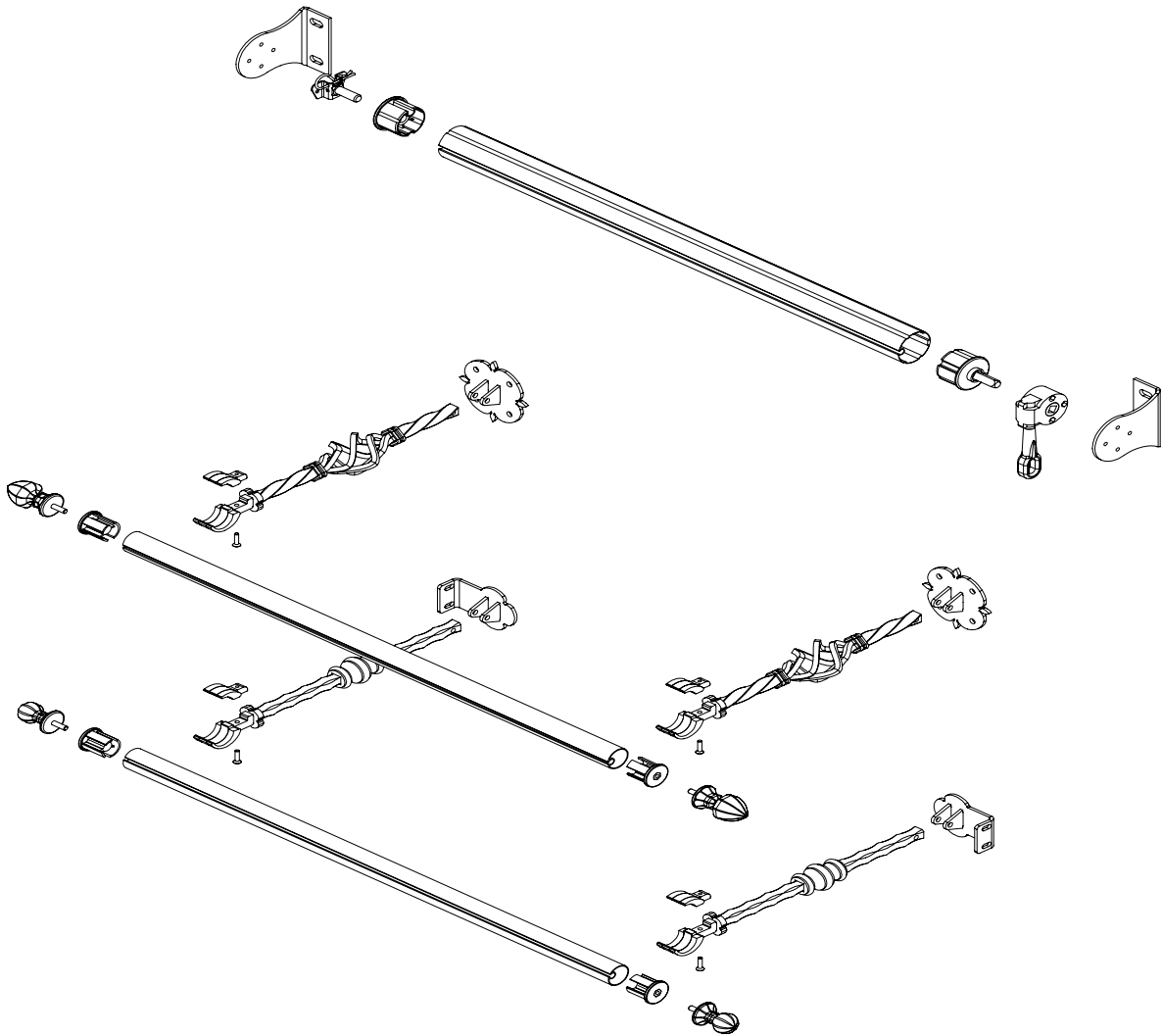

Colori di serie / Standard color / Couleurs standard



Arabescato
Rame

Arabescato
Grigio

Il materiale è pre-zincato elettroliticamente prima della verniciatura.

The material is pre-galvanized electrolytically before painting.

Altri colori / Another colors / Autres couleurs +20%

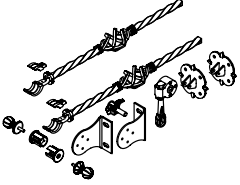
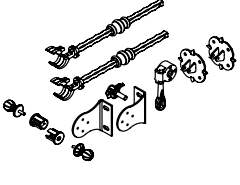
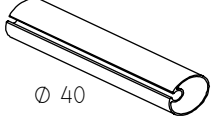
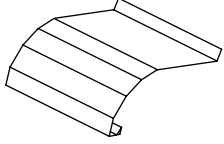
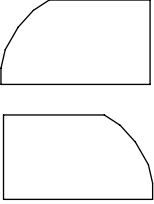
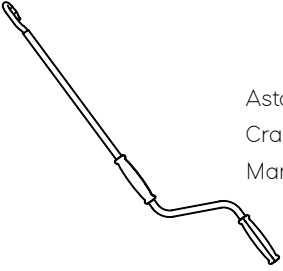
Disegno Figure Dessign	Descrizione Description Description	Informazioni Informations Information	Codice Article Code Code Article	U.M. Unit	Prezzo unitario Unit price Prix unitaire	Conf. std. Std. pack Cf. std
	Kit retro' attorcigliato Kit retro' twisted Kit retro' entortillé	Cm 70	RETRO 560 ATT			
		Cm 90	RETRO 760 ATT			
		Cm 110	RETRO 960 ATT	Pz		5
		Cm 130	RETRO 1160 ATT			
		Cm 150	RETRO 1360 ATT			
	Kit retro' quadro Kit retro' square Kit retro' carré	Cm 70	RETRO 560 QUA			
		Cm 90	RETRO 760 QUA			
		Cm 110	RETRO 960 QUA	Pz		5
		Cm 130	RETRO 1160 QUA			
		Cm 150	RETRO 1360 QUA			
 Ø 40	Terminale tortiglione Terminal profile tortiglione Barre de charge tortiglione	Cm 300	RETRO3STERM			
		Cm 400	RETRO4STERM	Pz		10
		Cm 500	RETRO5STERM			
				515gr/ml		
	Tettino di protezione Canopy of protection m3 Auvent de protection	Cm 300	RETRO3STETT			
		Cm 400	RETRO4STETT	Pz		1
		Cm 500	RETRO5STETT			
(zincato e verniciato fino a 4 mt, oltre 4 mt. in alluminio) / (galvanized and painted up to 4 m, over 4 m aluminum) (galvanisé et peint jusqu'à 4 mt, plus de 4 mt. en aluminium)						
	Tappi per tettino Caps for roof Bouchons pour auvent	RETROTAPPI		Cp		1
	Asta di manovra verniciata Crank handle Manivelle	Cm 100	AST0A100			
		Cm 120	AST0A120			
		Cm 150	AST0A150			
		Cm 180	AST0A180	Pz		10
		Cm 200	AST0A200			
		Cm 220	AST0A220			
		Cm 250	AST0A250			
Cm 300	AST0A300					

VENEZIA

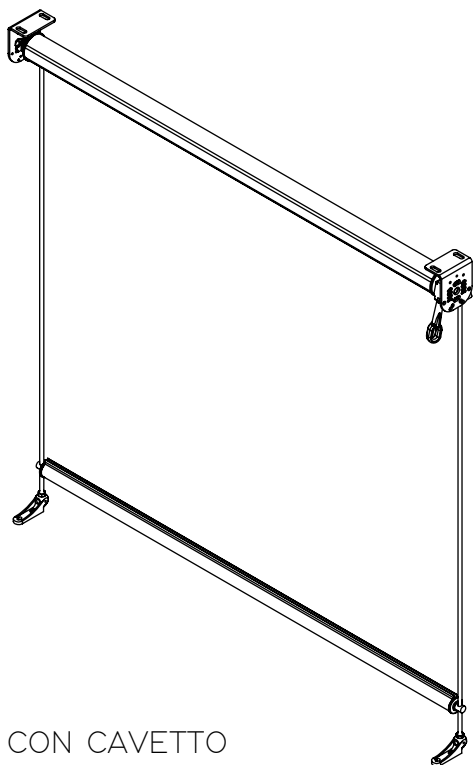

VENEZIA CON CAVETTO
VENEZIA WITH CABLE
VENEZIA AVEC CABLE

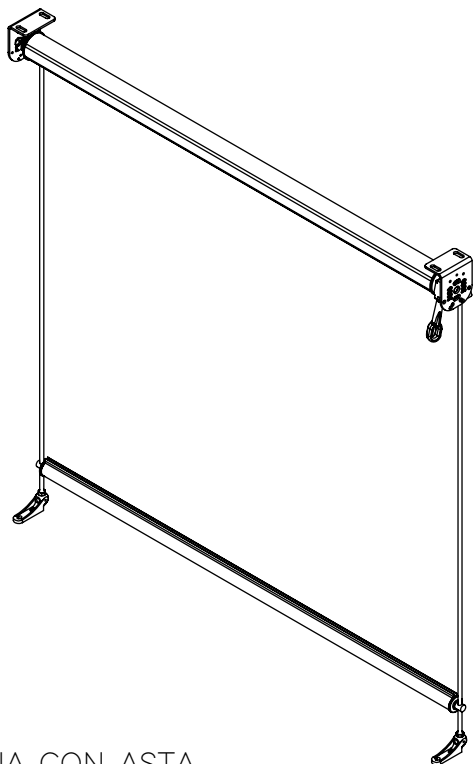
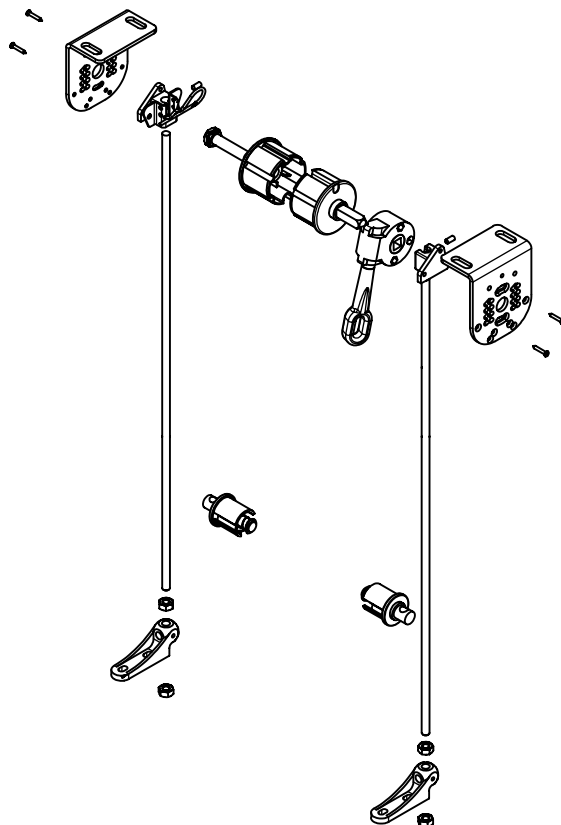

VENEZIA CON ASTA
VENEZIA ROD
VENEZIA AVEC TIGE

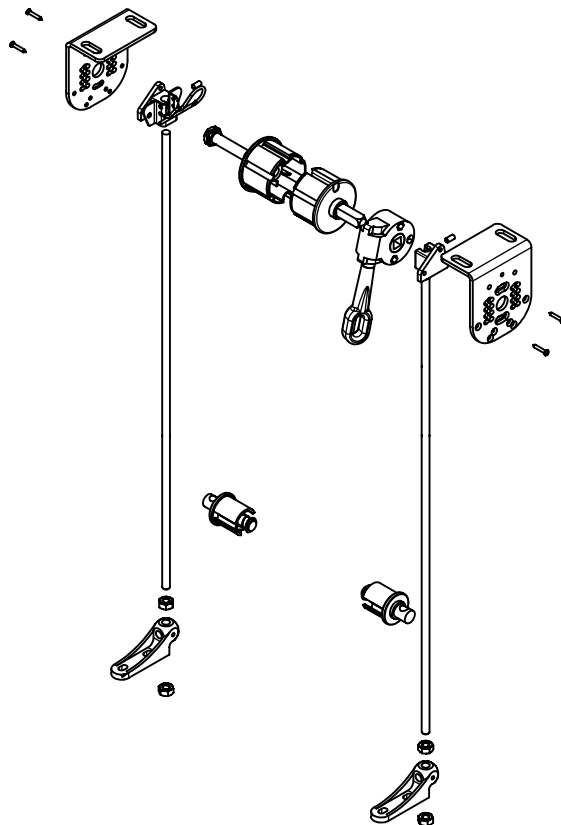

Colori di serie / Standard color / Couleurs standard



Ral
Bianco
9010

Ral
Avorio
1013

Ral
Grigio
7035

Altri colori / Another colors / Autres couleurs +20%

VENEZIA CASSONETTO TONDO

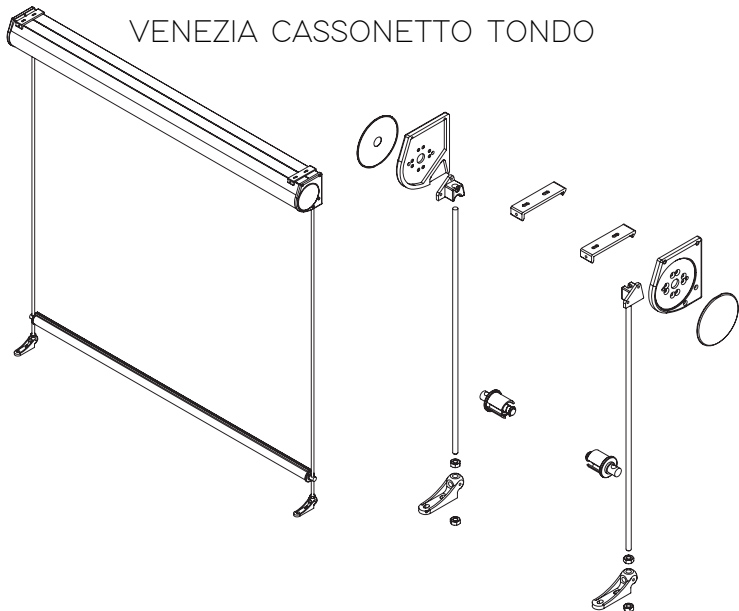

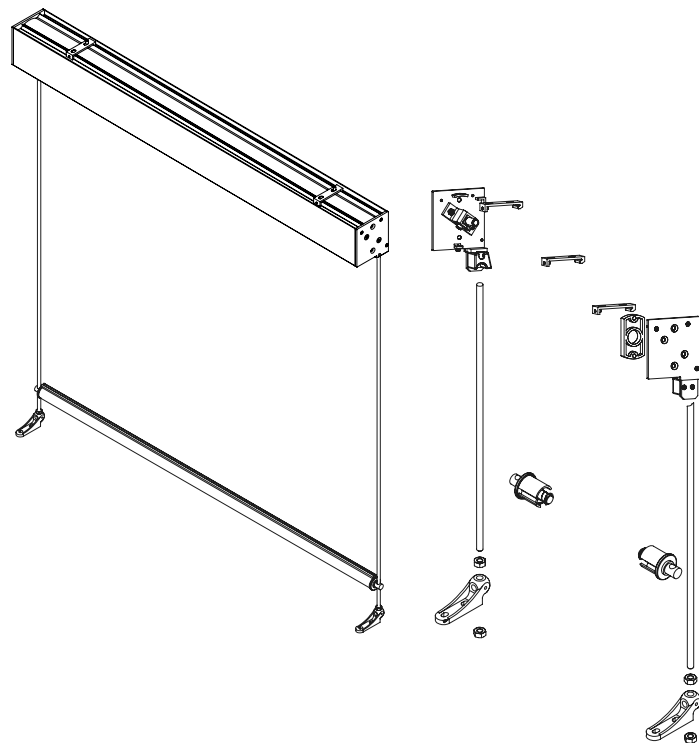

VENEZIA CASSONETTO QUADRO



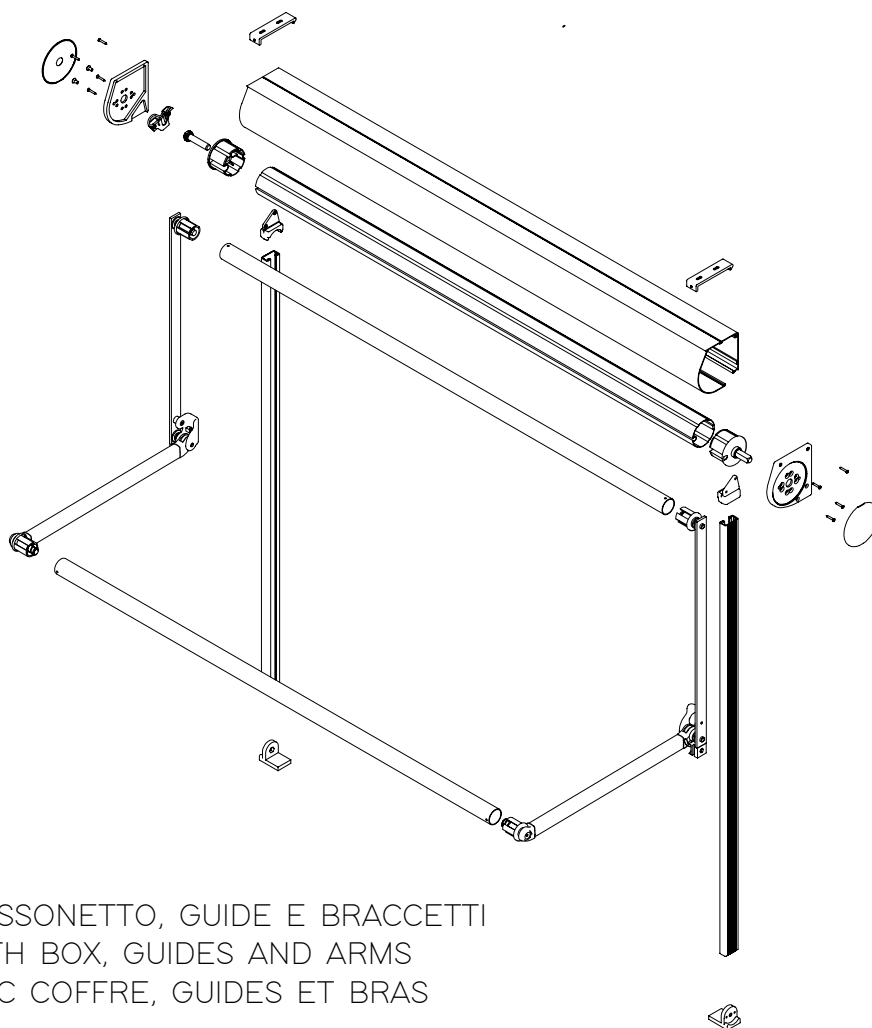

VENEZIA CON CASSONETTO E CAVETTO / ASTA
 VENEZIA WITH BOX AND CABLE / ROD
 VENEZIA WITH BOX AND CABLE / TIGE

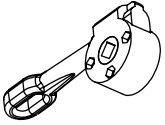
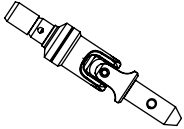

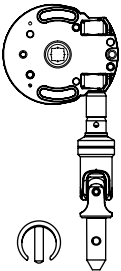
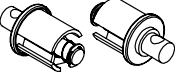
VENEZIA CON CASSONETTO, GUIDE E BRACCETTI
 VENEZIA WITH BOX, GUIDES AND ARMS
 VENEZIA AVEC COFFRE, GUIDES ET BRAS

Disegno Figure Dessign	Descrizione Description Description	Informazioni Informations Information	Codice Article Code Code Article	U.M. Unit	Prezzo unitario Unit price Prix unitaire	Conf. std. Std. pack Cf. std
	Arganello 11:1 Awning gearbox 11:1 Treuil 11:1		ARG11:1A	Pz	€	25
	Arganello 10:1 per supporto Calamitato Winch 10:1 for magnetic support Treuil 10:1 pour support magnétique		ARG10:1CAL	Pz	€	25
	Supporto Calamitato Magnetic support Support magnétique		SEMICARD.CAL.	Pz	€	25
	Anello di giunzione Junction ring Anneau de jonction		FERMA-ASTA	Pz	€	25
	Arganello 10:1 con supporto Calamitato completo Winch 10:1 with complete magnetic support Treuil 10:1 avec support magnétique complet		ARG10:1CAL.COMP	Pz	€	25
	Tappi cassonetto tcl/venezia Caps for box tcl/venezia Bouchons coffre tcl/venezia		TCL0025A	Cp	€	10
	Supporti cassonetto tcl/venezia Support for box tcl/venezia Supports coffre tcl/venezia		TCL0A015	Cp	€	10
	Tappo ø 70 con perno quadro 13x40 Plug with square pin 13x40 ø 70 Embout ø 70 avec axe carré 13x40		TAPPQ70-13x40	Pz	€	80
	Tappo ø 70 con foro ø 14 Plug ø 70 with hole ø 14 Embout ø 70 avec trou ø 14		TAPF70	Pz	€	200
	Calotta ø 40 per cavetto guida ø 4 mm Caps d.40 For cable guide ø 4 mm Embout ø 40 pour cable guide ø 4 mm		TAPCAV40A	Cp	€	10
	Calotta ø 40 per asta guida ø 10 mm Cap ø 40 for rod guide ø 10 mm Embout ø 40 pour tige guide ø 10 mm		TAPAST40A	Cp	€	10
	Calotta ø 40 per asta /cavo con fermo Cap ø 40 for rod cable still Embout ø 40 pour tige/cable avec arrêt		TAPBLOK40	Cp	€	10

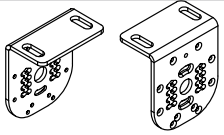
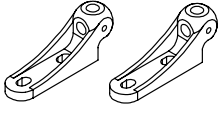
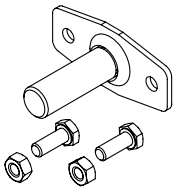
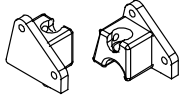
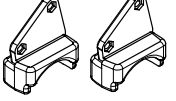
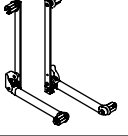
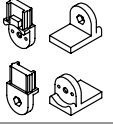
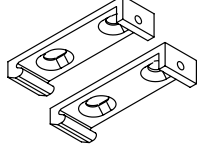
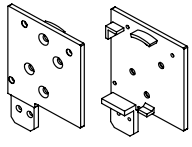
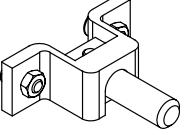
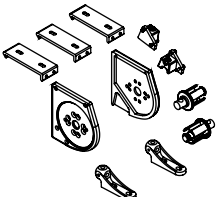
Disegno Figure Dessign	Descrizione Description Description	Informazioni Informations Information	Codice Article Code Code Article	U.M. Unit Unit	Prezzo unitario Unit price Prix unitaire	Conf. std. Std. pack Cf. std
	Cavetto guida inox ø 4 mm con vite e morsetto	Cm 100	VEN1A005			
	Cable guide inox ø 4 with screws and clamp	Cm 200	VEN2A005	Cp		10
	Cable guide inox ø 4 mm avec vis et pinces	Cm 300	VEN3A005			
	Asta guida inox ø 10 mm con vite	Cm 100	VEN1A006			
	Rod guide inox ø 10 with screws	Cm 200	VEN2A006	Cp		10
	Tringle guide inox ø 10 mm avec vis	Cm 300	VEN3A006			
	Staffa p/s venezia Bracket p/s venezia Bride p/s venezia		TNRS0A006	Cp		25
	Piedini universali per asta e cavetto Universal feet for rod and cable Pieds universels pour tige et câble	Asta	DROP0A007			
		Cavetto	DROP0A008	Cp		10
PIASTRINA CON PERNO / PLATE WITH PIN / PLAQUE AVEC AXE						
	Senza bulloni e dadi Without bolts and nuts Sans boulons et écrous	14x40	PCP00001			
	Con bulloni M6x16 e dadi M6 With bolts and nuts M6x16 e dadi M6 Avec boulons et écrous M6x16 e dadi M6	14x75	PCP00002	Pz		100
		14x40	PCP00003			
		14x75	PCP00004			
	Inserto superiore cavo/asta Upper cable / rod insert Insert supérieur cable/tringle		VNZ-008A	Cp		10
	Inserto superiore guida Upper guide insert Insert supérieur guide		VNZ-010A	Cp		10
	Braccetti tms a molla Awning arms with spring tms Bras avec ressort		TMS0A005	Cp		10
	Piedino singolo Leg single Pied simple		TMS0A006	Cp		10
	Supporti cassonetto quadro 10 x 10 Square box supports 10 x 10 Supports de boîte carrée 10 x 10		TCLO-003	Cp		10
	Tappi cassonetto quadro 10 x 10 Caps for box tcl 10 x 10 Bouchons coffre tcl 10 x 10		TCLO-030	Cp		5
	Perno estraibile cassonetto quadro 10 x 10 Square box removable pin 10 x 10 Broche amovible boîte carrée 10 x 10		TCLO-029	Pz		5
	Kit venezia cassonetto tondo Kit venezia with box round Kit venezia boîte ronde	Cavetto	KIT VENCAV	Pz		10

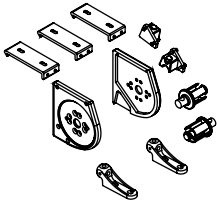
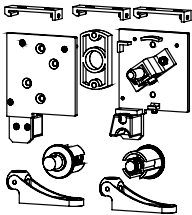
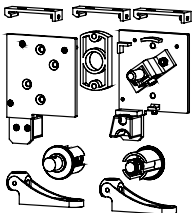
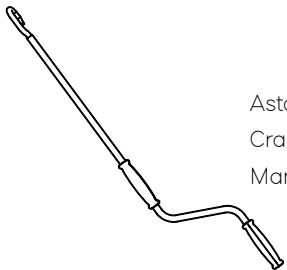
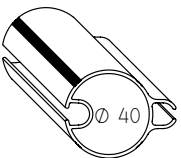
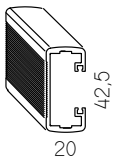
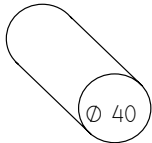
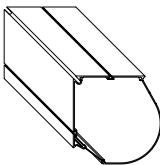
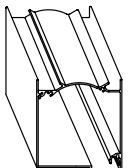
Disegno Figure Dessign	Descrizione Description Description	Informazioni Informations Information	Codice Article Code Code Article	U.M. Unit Unit	Prezzo unitario Unit price Prix unitaire	Conf. std. Std. pack Cf. std
	Kit venezia cassonetto tondo Kit venezia with box round Kit venezia boîte ronde	Asta	KIT.VENAST	Pz		10
	Kit venezia cassonetto quadro Kit venezia square box Kit venezia carré boîte	Cavetto	KIT.VENCCQ	Pz		10
	Kit venezia cassonetto quadro Kit venezia square box Kit venezia carré boîte	Asta	KIT.VENACQ	Pz		10
	Asta di manovra verniciata Crank handle Manivelle	Cm 100 Cm 120 Cm 150 Cm 180 Cm 200 Cm 220 Cm 250 Cm 300	AST0A100 AST0A120 AST0A150 AST0A180 AST0A200 AST0A220 AST0A250 AST0A300	Pz		10
	Terminale tms ø 40 Terminal profile tms ø 40 Barre de charge tms/gold ø 40	Cm 400 Cm 500 Cm 600 Cm 700 725gr/ml	TMS4A010 TMS5A010 TMS6A010 TMS7A010	Pz		10
	Guida tms Guide allum. Tms Guide tms	Cm 700 610gr/ml	TMSA700	Pz		10
	Frangivento p-gold ø 40 Windbreak p-gold ø 40 Brise-vent p-gold ø 40	Cm 400 Cm 500 Cm 600 Cm 700 515gr/ml	TMS4A003 TMS5A003 TMS6A003 TMS7A003	Pz		10
	Cassonetto di protezione Box of protection Coffre de protection	Cm 400 Cm 500 Cm 700 2339gr/ml	TCL4A003 TCL5A003 TCL7A003	Pz		10
	Cassonetto di protezione quadro Square protection box Coffre de protection carrée	Cm 400 Cm 500 Cm 700 2237gr/ml	TCLO4A001 TCLO5A001 TCLO7A001	Pz		10

Note

A large rectangular area with horizontal dotted lines, intended for writing notes.

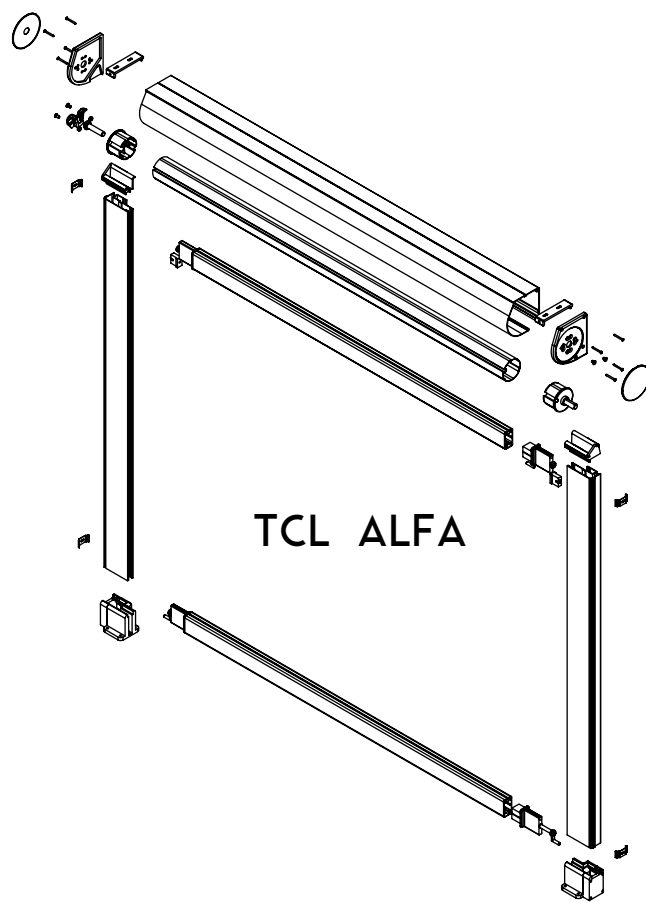

TCL ALFA

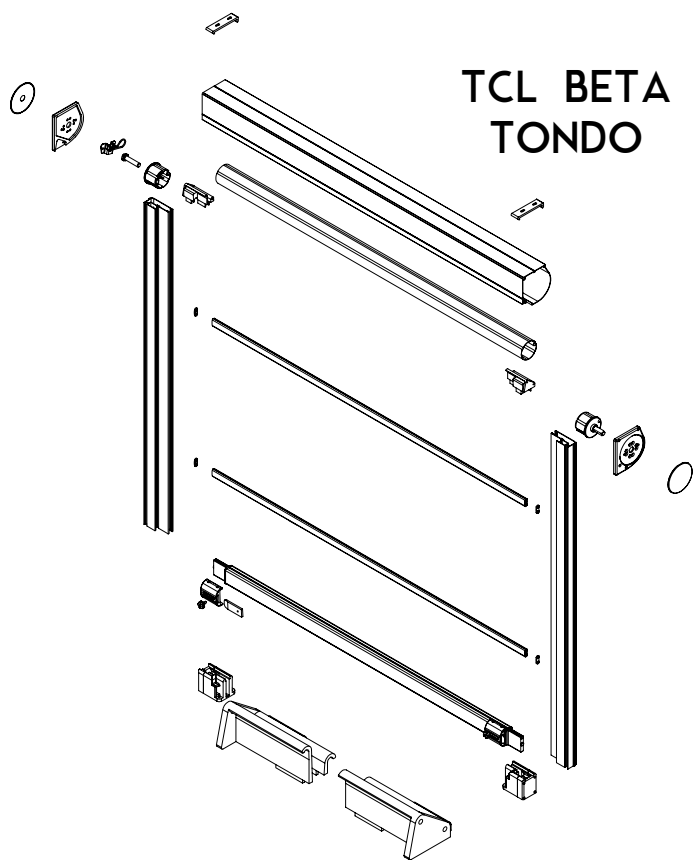

**TCL BETA
TONDO**

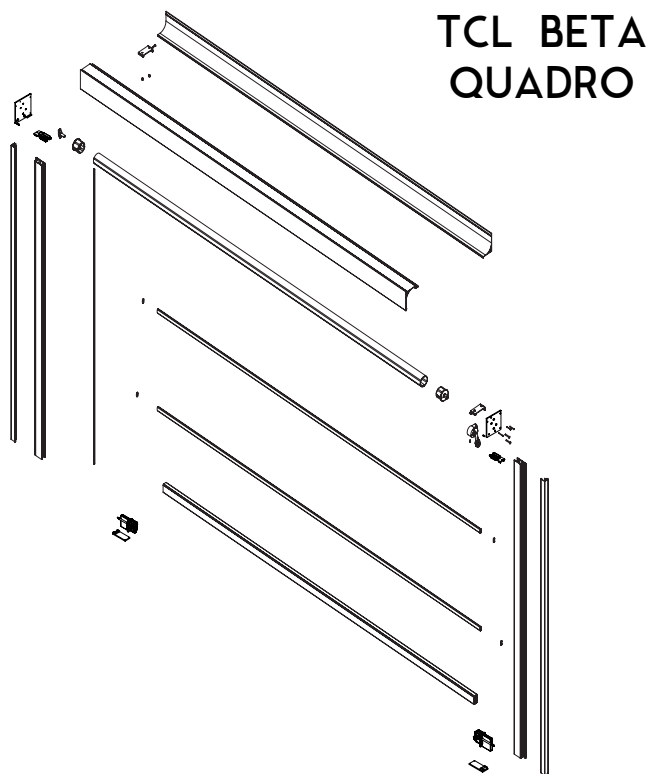

**TCL BETA
QUADRO**

Colori di serie / Standard color / Couleurs standard



Ral
Bianco
9010

Ral
Avorio
1013

Ral
Marrone
8017



Ral
Antracite

Ral
Corten

Altri colori / Another colors / Autres couleurs +20%

Disegno Figure Dessign	Descrizione Description Description	Informazioni Informations Information	Codice Article Code Code Article	U.M. Unit Unit	Prezzo unitario Unit price Prix unitaire	Conf. std. Std. pack Cf. std
	Arganello 7:1 Awning gearbox 7:1 Treuil 7:1		ARG7:1A	Pz		25
	Arganello 10:1 per supporto Calamitato Winch 10:1 for magnetic support Treuil 10:1 pour support magnétique		ARG10:1CAL	Pz		25
	Supporto Calamitato Magnetic support Support magnétique		SEMICARD.CAL.	Pz		25
	Anello di giunzione Junction ring Anneau de jonction		FERMA-ASTA	Pz		25
	Arganello 10:1 con supporto Calamitato completo Winch 10:1 with complete magnetic support Treuil 10:1 avec support magnétique complet		ARG10:1CAL.COMP	Pz		25
	Supporti cassonetto tcl/venezia Support box tcl / venezia allum. Supports coffre tcl/venezia		TCL0A015	Cp		10
	Tappi cassonetto tcl Caps for box tcl/venezia Bouchons coffre tcl/venezia		TCL0025A	Cp		5
	Innesto superiore per guida tcl Cassonetto tondo esterno Graft support guide tcl allum. Box outer round Support supérieur pour guide tcl Coffre rond extérieur		TCL0022	Cp		5
	Innesto superiore per guida tcl Cassonetto tondo interno Graft support guide tcl allum. Box inner round Support supérieur pour guide tcl Coffre rond intérieur		TCL0A044	Cp		5
	Piedino per guida tcl con aggancio Catenacciolo Leg for guide allum. Tcl with Hooking latch Pied pour guide tcl avec accrochage loquet		TCL0001C-A	Cp		5
	Catenacciolo Latch allum. tcl Loquet		TCL0A001	Cp		5
	Piastrina con perno 14x40 Plate with pin 14x40 Plaquette avec axe 14x40		PCP00001	Pz		100
	Tacchetto per bloccaggio frangivento Cleat for locking windbreak Clou pour blocage brise-vent		TCL0028A	Pz		20

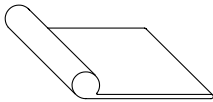
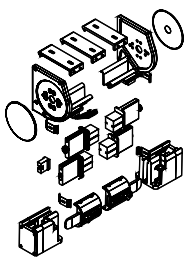
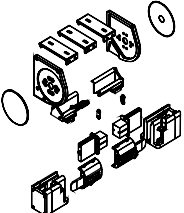
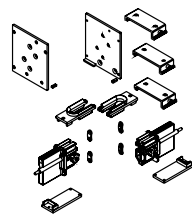
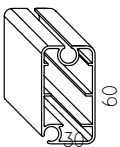
Disegno Figure Dessign	Descrizione Description Description	Informazioni Informations Information	Codice Article Code Code Article	U.M. Unit Unit	Prezzo unitario Unit price Prix unitaire	Conf. std. Std. pack Cf. std
	Tappi terminale tcl manuale Caps terminal tcl manuale Bouchons barre de charge tcl manual		TCL0018A	Cp		5
	Tappo frangivento Caps windbreak tcl Bouchon brise-vent		TCL0027A	Cp		5
	Tappo ø 70 con perno quadro 13x25 Plug with square pin 13x25 ø 70 Embout ø 70 avec axe carré 13x25		TAPPQ70-13x25	Pz		5
	Tappo con foro ø 70 Plug ø 70 with hole ø 14 Embout avec trou ø 70		TAPF70	Pz		200
	Tappo terminale frangivento tcl beta Plug windbreak terminal tcl beta Capuchon coupe-vent tcl beta		TCL0A005	Cp		10
	Fermo a scatto per guida Anchorage overhead for insect Screen with spring Arrêt pour guide		ZANZ046	Pz		20
	Supporto soffitto x cass quadro Celing support for squared box Support de plafond pour panneau carré		TCLZ-014	Pz		5
	Innesto superiore per guida tcl Cassonetto quadro Upper clutch for tcl Square box Raccord supérieur pour guide tcl Boîte carrée		TCLB-008	Cp		5
	Perno estraibile cassonetto quadro Square box removable pin Broche amovible boîte carrée		TCLO-029	Pz		5
	Piedino per guida tcl con Catenacciolo Foot for tcl guide with Catenacciolo Pied pour guide tcl avec catenacciolo		TCLB-021	Cp		5
	Tappi cassonetto quadro 13 x 13 Square box caps 13 x 13 Capsules carrées 13 x 13		TCL0025AGAM	Cp		5
	Tappi terminale tcl manuale Caps terminal tcl manuale Embouts manuels tcl		TCLB-011	Cp		5
	Spazzolino / brush / brosse 5mm Spazzolino / brush / brosse 9mm Spazzolino / brush / brosse 11mm Spazzolino a 45°/brush 45°/brosse 45°		TCL-018 TCL-017 TCL-016 TCL-019	MI		1000 650 600 500
	Guarnizione palloncino terminale tcl beta Tcl beta terminal balloon seal Joint de ballon terminal bêta Tcl	Cm 700	TCL0013	Pz		50

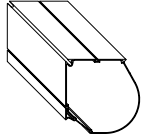
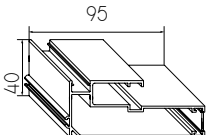
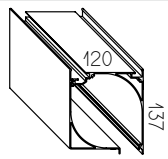
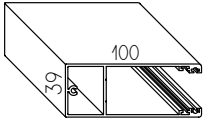
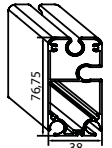
Disegno Figure Design	Descrizione Description Description	Informazioni Informations Information	Codice Article Code Code Article	U.M. Unit Unit	Prezzo unitario Unit price Prix unitaire	Conf. std. Std. pack Cf. std
	Guarnizione terminale Terminal profile gasket Joint terminal		TCL0017	MI		50
	Kit accessori TCL ALFA TCL ALFA accessory kit Kit d'accessoires TCL ALFA		KIT-TCLA	Pz		1
	Kit accessori TCL BETA Cass.Tondo TCL BETA Round Cassette Accessory Kit Kit d'accessoires TCL BETA Boîte ronde		KIT-TCLBT	Pz		1
	Kit accessori TCL BETA Cass.Quadro TCL BETA Cass.Quadro accessory kit TCL BETA Cass.Quadro kit d'accessoires		KIT-TCLBQ	Pz		1
	Terminale frangivento tcl Terminal windbreak tcl Barre de charge brise-vent tcl	Cm 700 1045gr/ml	TCLB7A001	Pz		10
	Frangivento tcl beta Windbreak tcl beta Brise-vent tcl beta	Cm 700 306gr/ml	TCL7A005	Pz		10
	Cassonetto di protezione Box of protection Coffre de protection	Cm 400 Cm 500 Cm 700 2339gr/ml	TCL4A003 TCL5A003 TCL7A003	Pz		10
	Guida laterale tcl Guide side tcl Guide tcl	Cm 450 Cm 600 1457gr/ml	TCL4,5A001 TCL6A001	Pz		10
	Cassonetto di protezione quadro Square protection box Coffre de protection carrée	Cm 400 Cm 500 Cm 700 3787gr/ml	TCL4A003GAM TCL5A003GAM TCL7A003GAM	Pz		10
	Guida laterale tcl Beta quadro Guide side tcl Guide tcl carrée	Cm 500 1641gr/ml	TCLB5A00	Pz		10
	Terminale tcl Terminal tcl Barre de charge tcl	Cm 400 Cm 500 Cm 700 1819gr/ml	TCL4A002 TCL5A002 TCL7A002	Pz		10

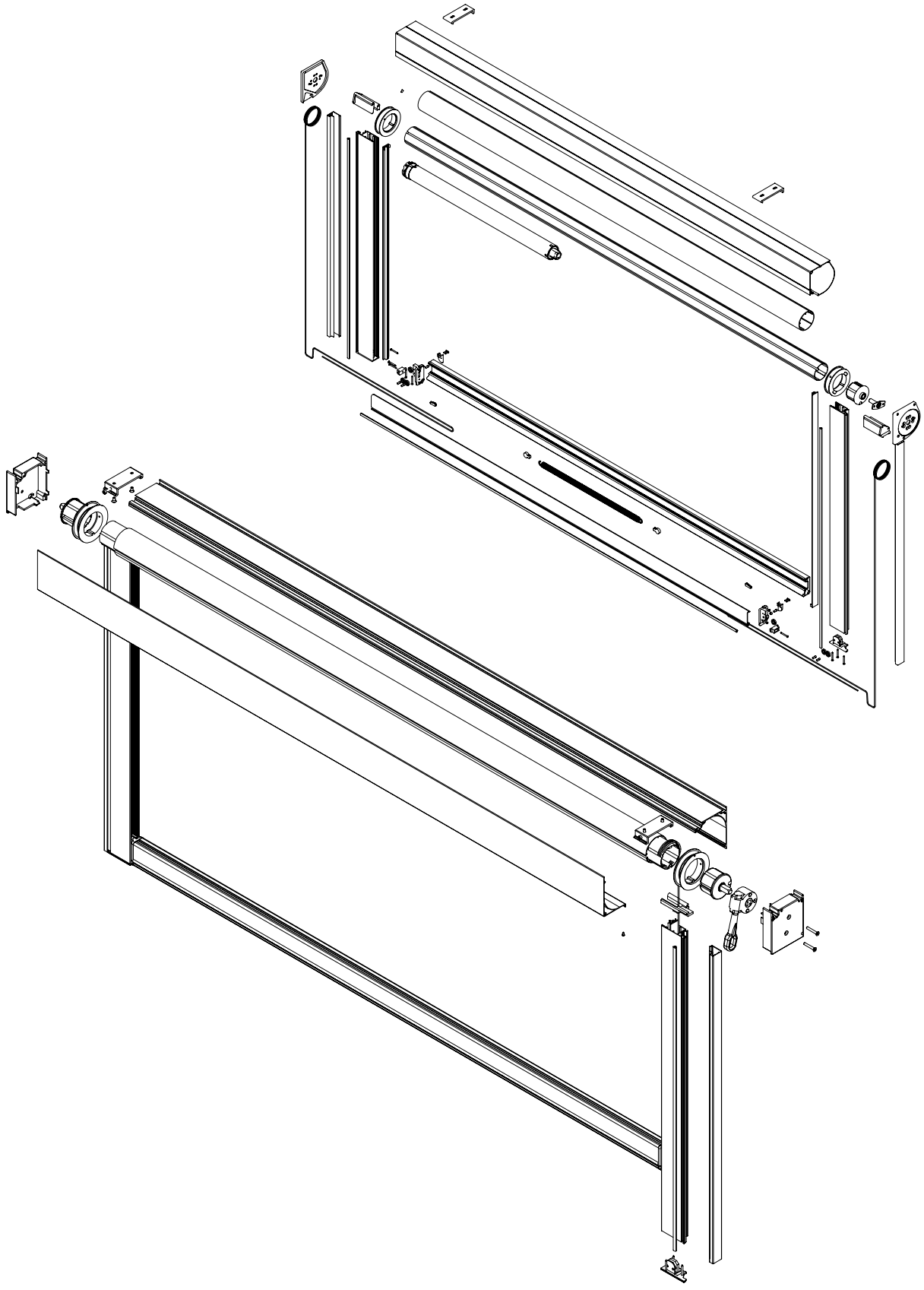

Colori di serie / Standard color / Couleurs standard



Ral
Bianco
9010

Ral
Avorio
1013





Ral
Marrone
8017

Ral
Antracite

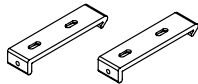
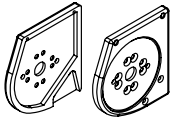
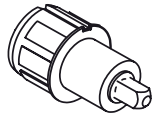
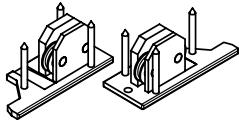
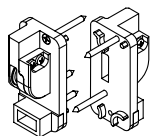
Ral
Corten

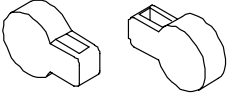
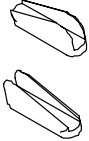
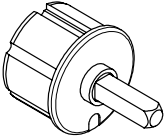
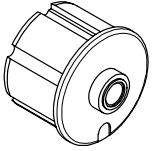
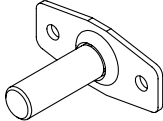
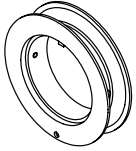
Altri colori / Another colors / Autres couleurs +20%

Disegno Figure Design	Descrizione Description Description	Informazioni Informations Information	Codice Article Code Code Article	U.M. Unit Unit price	Prezzo unitario Unit price Prix unitaire	Conf. std. Std. pack Cf. std
	Arganello 7:1 Awning gearbox 7:1 Treuril 7:1		ARG71A	Pz		25
	Supporti cassonetto tcl/venezia Support box tcl / venezia allum. Supports coffre tcl/venezia		TCL0A015	Cp		10
	Tappi cassonetto tcl Caps for box tcl/venezia Bouchons coffre tcl		TCL0025A	Cp		5
	Innesto superiore per guida tcl gamma Cassonetto tondo Upper clutch for tcl gamma guide Round cassette Embrayage supérieur pour guide de tcl gamma Cas ronde		TCLZ-021	Cp		5
	Supporto soffitto x cass quadro Ceiling support for squared box Support de plafond pour panneau carré		TCLZ-014	Pz		5
	Invito per zip Zip invitation Invitation Zip		TCLZ-050	Pz		5
	Tappo avvolgitore con perno quadro Ø 70 Winder cap with square pin Ø 70 Bouchon à rouler avec goupille carrée Ø 70		TCLZ-038	Pz		5
	Tappo avvolgitore motore tcl gamma Tcl gamma motor winder cap Capuchon d'enrouleur de moteur gamma Tcl		TCLZ-039	Pz		5
	Tappo avvolgitore con foro tcl gamma Rolling cap with hole tcl gamma Rolling cap avec trou tcl gamma		TCLZ-037	Pz		5
	Innesto superiore per guida tcl Cassonetto quadro Upper clutch for tcl Square box Embrayage supérieur pour tcl Boîte carrée		TCLZ-025	Cp		5
	Piedino per guida tcl gamma Leg for guide tcl gamma Pied pour guide de tcl gamma		TCLZ-035	Cp		5
	Tappi terminale tcl gamma Caps terminal tcl gamma Embouts tcl gamma		TCLZ-034	Cp		5
	Tappi cassonetto quadro Square box caps Capsules carrées		TCL0025AGAM	Cp		5

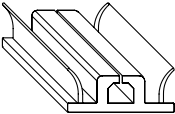
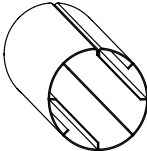
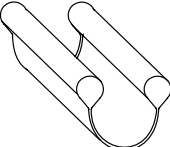
Disegno Figure Dessign	Descrizione Description Description	Informazioni Informations Information	Codice Article Code Code Article	U.M. Unit Unit	Prezzo unitario Unit price Prix unitaire	Conf. std. Std. pack Cf. std
	Carrucola gamma Pulley gamma Poulie gamme		TCL0027AGAM	Pz	€	5
	Fermacorda gamma Rope stropper gamma Bouchon de gamme		TCL0028AGAM	Pz	€	5
	Tappo ø 70 con perno quadro 13x25 Plug with square pin 13x25 ø 70 Embout ø 70 avec axe carré 13x25		TAPPQ70-13x25	Pz	€	80
	Tappo con foro ø 70 Plug ø 70 with hole ø 14 Embout avec trou ø 70		TAPF70	Pz	€	200
	Piastrina con perno 14x40 Plate with pin 14x40 Plaquette avec axe 14x40		PCP00001	Pz	€	100
	Puleggia tcl gamma Pulley tcl gamma Poulie TCL gamma		TCLZ-047	Pz	€	10
	Molla terminale tcl gamma Spring terminal profile tcl gamma Ressort terminal tcl gamma		TCLMOL	Pz	€	5
	Spazzolino 5mm Brush 3mm Brosse 3mm		TCL-018	MI	€	1000
	Cordino Rope cordon		GIO.CORDA	MI	€	250
	Slim per guida Slim for guide Slim pour conduire	Cm 400 Cm 500 Cm 600 Cm 700	VAI13	Pz	€	10
	Spessore per tubo zip ml.3 Thickness for zip ml. 3 Épaisseur pour le tube zip ml.3		TCL0026AGAM	Pz	€	5
	Guarnizione a palloncino per Terminale Gasket for terminal profile tcl Joint de ballon pour terminal		TCL0023	MI	€	50

Disegno Figure Dessign	Descrizione Description Description	Informazioni Informations Information	Codice Article Code Code Article	U.M. Unit	Prezzo unitario Unit price Prix unitaire	Conf. std. Std. pack Cf. std
------------------------------	---	---	--	--------------	--	------------------------------------

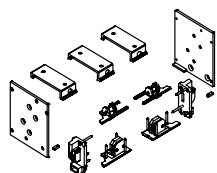

KIT TCL Gamma cassonetto Quadro
KIT TCL Quadro box range
KIT TCL Quadro box gamme

KIT-TCLCQ

Pz

1

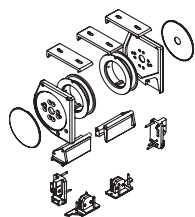

KIT TCL Gamma cassonetto Tondo
TCL KIT Round box range
TCL KIT Gamme de boîtes rondes

KIT-TCLBT

Pz

1



Asta di manovra verniciata
Crank handle
Manivelle

Cm 100 AST0A100
Cm 120 AST0A120
Cm 150 AST0A150
Cm 180 AST0A180
Cm 200 AST0A200
Cm 220 AST0A200
Cm 250 AST0A250
Cm 300 AST0A300

Pz

10

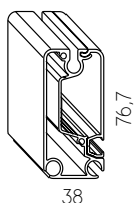

Terminale tcl gamma
Terminal tcl gamma
Barre de charge tcl delta

Cm 700 TCL7A004GAM
1819gr/ml

Pz

10

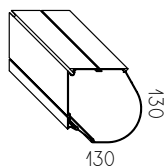

Cassonetto di protezione
Box of protection
Coffre de protection

Cm 400 TCL4A003
Cm 500 TCL5A003
Cm 700 TCL7A003
2339gr/ml

Pz

10

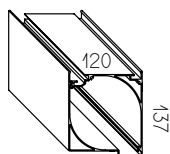

Cassonetto di protezione quadro 13 X 13
Square protection box 13 X 13
Coffre de protection carrée 13 X 13

Cm 400 TCL4A003GAM
Cm 500 TCL5A003GAM
Cm 700 TCL7A003GAM
3787gr/ml

Pz

10

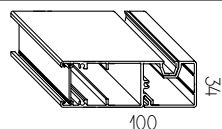

Guida completa tcl gamma
Complete guide tcl gamma
Guide tcl delta

Cm 500 TCL5A000GAM
1641gr/ml

Pz

10

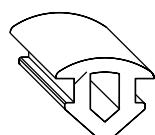

Guarnizione x profilo guida
Seal for guide profile
Joint pour profil de guidage

CAP00021

MI

150

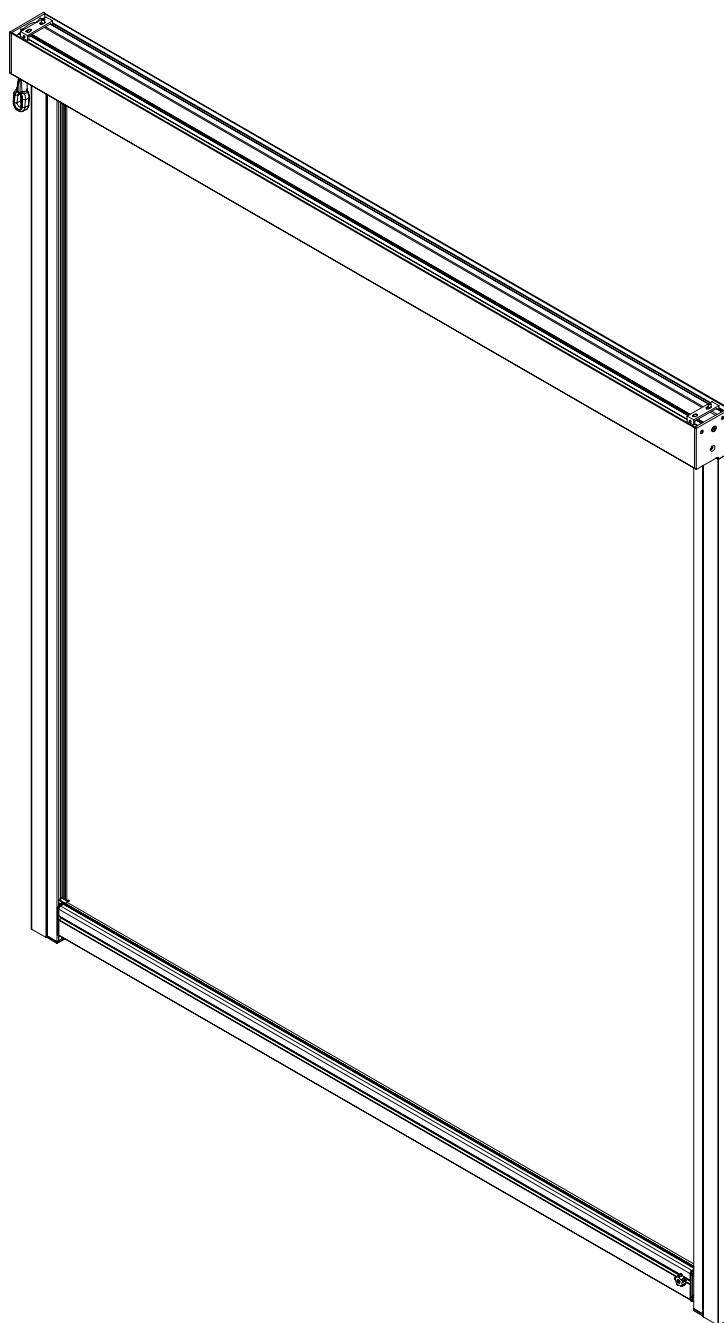

Colori di serie / Standard color / Couleurs standard



Ral
Bianco
9010

Ral
Avorio
1013

Ral
Marrone
8017

Ral
Corten

Ral
Antracite

Altri colori / Another colors / Autres couleurs +20%

Disegno Figure Design	Descrizione Description Description	Informazioni Informations Information	Codice Article Code Code Article	U.M. Unit Unit	Prezzo unitario Unit price Prix unitaire	Conf. std. Std. pack Cf. std
	Arganello 10:1 per supporto Calamitato Winch 10:1 for magnetic support Treuil 10:1 pour support magnétique		ARG10:1CAL	Pz		25
	Supporto Calamitato Magnetic support Support magnétique		SEMICARD.CAL	Pz		25
	Anello di giunzione Junction ring Anneau de jonction		FERMA-ASTA	Pz		25
	Arganello 10:1 con supporto Calamitato completo Winch 10:1 with complete magnetic support Treuil 10:1 avec support magnétique complet		ARG10:1CAL.COMP	Pz		25
	Supporti cassonetto tcl omega Support box tcl omega Supports coffre tcl omega		TCL0-003	Cp		10
	Tappi cassonetto 10 x 10 tcl Caps for box tcl Bouchons coffre tcl		TCL0-030	Cp		5
	Tappi cassonetto 13 x 13 tcl Caps for box tcl Bouchons coffre tcl		TCL0025AGAM	Cp		5
	Guarnizione palloncino terminale tcl beta Tcl beta terminal balloon seal Joint de ballon terminal bêta Tcl	Cm 700	TCL0013	Pz		50
	Tappi terminale tcl manuale Caps manual terminal tcl Embouts manuels tcl		TCL0-031	Cp		5
	Tappi terminale tcl automatica Caps terminal tcl Embouts tcl		TCL0-032	Cp		5

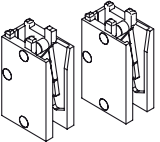
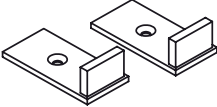
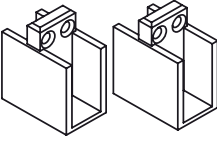
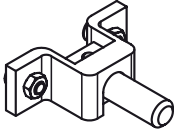
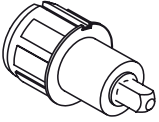
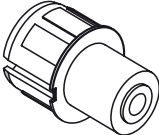
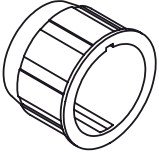
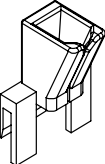
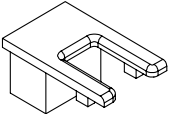
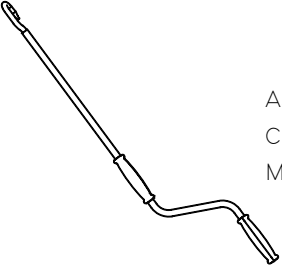
Disegno Figure Dessign	Descrizione Description Description	Informazioni Informations Information	Codice Article Code Code Article	U.M. Unit	Prezzo unitario Unit price Prix unitaire	Conf. std. Std. pack Cf. std
	Piedino per guida tcl omega automatica Foot for tcl automatic guide omega Pied pour guide automatique tcl Omega		TCLO-033	Cp		5
	Piedino per guida tcl omega manuale Leg for guide tcl omega manuale Pied pour guide de tcl omega manuale		TCLO-023	Cp		5
	Piedino per guida tcl omega manuale Leg for guide tcl omega manuale Pied pour guide de tcl omega manuale		TCLO-015	Cp		5
	Perno estraibile tcl omega Removable pin tcl omega Goupille amovible tcl omega		TCLO-029	Pz		5
	Tappo perno quadro tcl omega Ø 70 Square pin cap tcl omega Ø 70 Bouchon carré tcl omega Ø 70		TCLO-044	Pz		5
	Tappo con foro tcl omega Ø 70 Cap with hole tcl omega Ø 70 Casquette avec trou tcl omega Ø 70		TCLO-043	Pz		5
	Adattatore motore tcl omega Ø 70 Tcl omega engine adapter Ø 70 Adaptateur de moteur tcl omega Ø 70		TCLO-045	Pz		5
	Invito per zip Zip invitation Invitation Zip		TCLZ-050	Pz		5
	Inserto superiore guida Upper guide insert Insert de guidage supérieur		TCLO-042	Pz		5
	Asta di manovra verniciata Crank handle Manivelle	Cm 100 Cm 120 Cm 150 Cm 180 Cm 200 Cm 220 Cm 250 Cm 300	AST0A100 AST0A120 AST0A150 AST0A180 AST0A200 AST0A220 AST0A250 AST0A300	Pz		10

Disegno Figure Dessign	Descrizione Description Description	Informazioni Informations Information	Codice Article Code Code Article	U.M. Unit	Prezzo unitario Unit price Prix unitaire	Conf. std. Std. pack Cf. std
------------------------------	---	---	--	--------------	--	------------------------------------

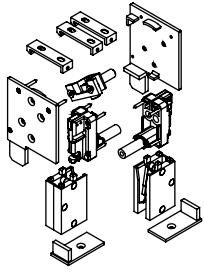

KIT TCL Omega cassonetto 10 x 10 automatica
 KIT TCL Omega 10 x 10 automatic box
 KIT TCL Omega 10 x 10 boîte automatique

KIT-TCLOA

Pz

5

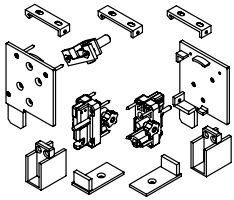

KIT TCL Omega cassonetto 10 x 10 manuale
 KIT TCL Omega box 10 x 10 manual
 KIT TCL Omega 10 x 10 boîte manuel

KIT-TCLOM

Pz

5

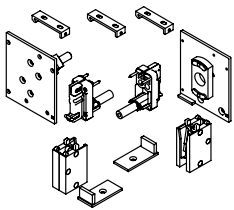

KIT TCL Omega cassonetto 12 x 12 manuale
 KIT TCL Omega box 12 x 12 manual
 KIT TCL Omega 12 x 12 boîte manuel

KIT-TCLO12A

Pz

5

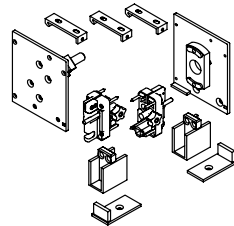

KIT TCL Omega cassonetto 12 x 12 manuale
 KIT TCL Omega box 12 x 12 manual
 KIT TCL Omega 12 x 12 boîte manuel

KIT-TCLO12M

Pz

5

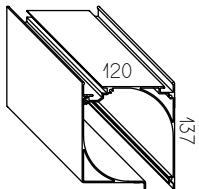

Cassonetto di protezione quadro 13 x13
 Square protection box 13 x13
 Coffre de protection carrée 13 x13

Cm 400

TCL4A003GAM

Cm 500

TCL5A003GAM

Pz

10

Cm 700

TCL7A003GAM

3787gr/ml

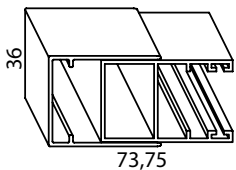

Guida telescopica
 Telescopic guide
 Guide télescopique

Cm 500

TCLO-037

Pz

7

1285gr/ml

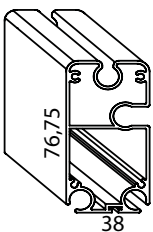

Terminale tcl
 Terminal tcl
 Barre de charge tcl

Cm 400

TCL4A002

Cm 500

TCL5A002

Pz

10

Cm 700

TCL7A002

1819gr/ml

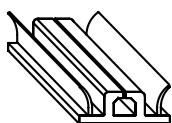

Slim per guida
 Slim for guide
 Slim pour conduire

Cm 400

Cm 500

Cm 600

Cm 700

VAI13

Pz

10

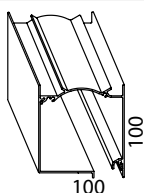

Cassonetto di protezione quadro
 Square protection box
 Coffre de protection carrée

Cm 400

TCLO4A001

Cm 500

TCLO5A001

Pz

10

Cm 700

TCLO7A001

2237gr/ml

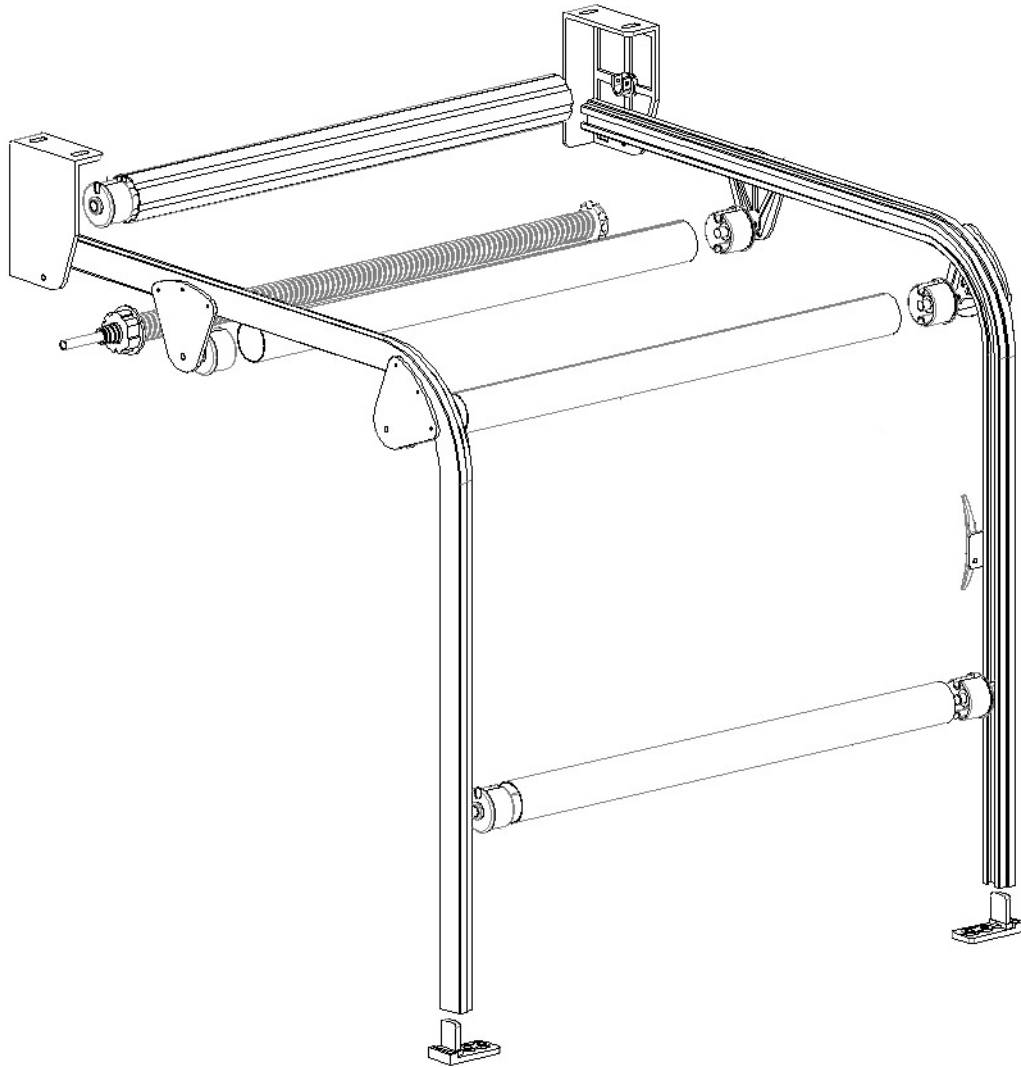

Colori di serie / Standard color / Couleurs standard



Ral
Bianco
9010

Ral
Avorio
1013

Ral
Marrone
8017

Ral
Grigio
7035

Ral
Antracite

Ral
Bronzo

Altri colori / Another colors / Autres couleurs +20%

Disegno Figure Dessign	Descrizione Description Description	Informazioni Informations Information	Codice Article Code Code Article	U.M. Unit Unit price	Prezzo unitario Unit price Prix unitaire	Conf. std. Std. pack Cf. std
	Arganello 11:1 gambo lungo Winch 11:1 long shank Treuil 11:1 tige longue		ARG11:1A160	Pz		25
	Molla assemblata ø 70 Spring assembled rod empty ø 70 Ressort assemblé ø 70	Cm 120 Cm 140 Cm 180	MOLLA120/70 MOLLA140/70 MOLLA180/70	Pz		10
	Staffe p/s regolabili in alluminio Adjustable bracket tmt wall / ceiling Allum Supports mur/plafond réglables en aluminium.		TMT0A019	Cp		10
	Staffa p/s accoppiata regolabile in Alluminio Adjustable bracket tmt wall / ceiling Coupled Support mur/plafond uni réglable en aluminium		TMT0A020DX TMT0A020SX	Pz		100
	Staffa tmt universale nuda Bracket simple universal tmt Support tmt universel simple		TMT0A025	Cp		10
	Staffa nuda accoppiata tranciata Bracket simple coupled allum. Support simple uni tracé		TMT0A027	Pz		10
	Piastrina in nylon con perno estraibile Plate nylon with removable pin Plaquette en nylon avec axe extraible		PES0005	Pz		100
	Tappo ø 70 con perno quadro 13x48 Plug with square pin 13x48 ø 70 Embout ø 70 avec axe carré 13x48		TAPPQ70-13x48	Pz		80
	Tappo con foro ø 70 Plug ø 70 with hole ø 14 Embout ø 70 avec trou ø 14		TAPF70	Pz		200
	Calotta scorrevole ø 60 Plug sliding ø 60 Embout coulissant ø 60	Zincata Inox	TAPSCORZINCA TAPSCORINOXA	Pz		100
	Calotta rompitratta ø 60 (Fisso) con perno Plug windbreak ø 60 (Fixed) with pin Embout brise-vent ø 60 (Fixe) avec axe	Zincata Inox	TAPFRAZIN60A TAPFRAINOX60ZA	Pz		100
	Calotta perno filettato ø 60 Plug threaded pin ø 60 Embout axe fileté ø 60	Zincata Inox	TMT000011A TMT000012A	Pz		100
	Cravatta perno e tappo ø 60 Per traverse frangivento Cap and pin dia60 (tie) windbreak Support axe e embout ø 60 Pour brise-vent		TMT0009A	Pz		50

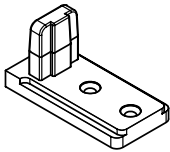
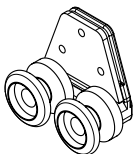
Disegno Figure Dessign	Descrizione Description Description	Informazioni Informations Information	Codice Article Code Code Article	U.M. Unit Unit	Prezzo unitario Unit price Prix unitaire	Conf. std. Std. pack Cf. std
	Cravatta in nylon stretta Tie close nylon Attache en nylon serré		TMT0A002	Pz	€	100
	Piedino singolo in alluminio Leg single allum. Pied simple en aluminium		TMT0A006	Pz		100
	Piedino doppio in alluminio Led double allum. Pied double en aluminium		TMT0A012	Pz		50
	Bitta avvolgifune in alluminio Bollard winder Taquet en aluminium		TMT0A001	Pz		50
	Triangolo (fazzoletto) Triangle allum. Tmt Triangle tmt		TMT0A003	Pz		50
	Triangolo accoppiato (fazzoletto doppio) Triangle coupled allum. Tmt Triangle uni tmt		TMT0A004	Pz		50
	Tacchetti in nylon 1 foro Nylon studs 1 hole Block en nylon 1 trou		TACFORO	Cp		100
	Curva snodata in alluminio Curve adjustable tmt Courbe réglable en aluminium		TMT0A015	Pz		10
	Fermo guida Stopper for guide tmt Arrêt guide	Zincata Inox	TMT00007D SG00015D	Pz		50
	Carrello scorrevole doppio Sliding trolley side double Charriot coulissant double		SCORLAT	Pz		10
	Supporto centrale per tmt con bullone e dado Support central for tmt with Bolt Support central pour tmt avec boulon et écrou	Molla Arganello	TMT0A022 TMT0A023	Pz		10
	Treccia mm. 10 Braid mm. 10 Corde mm. 10		TMT00008	MI		200

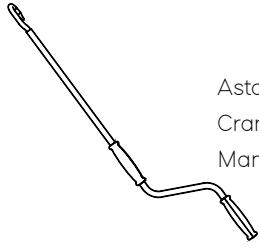
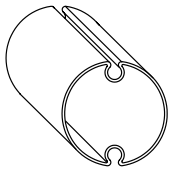
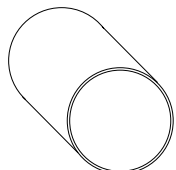
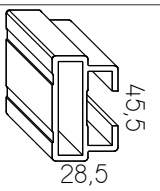
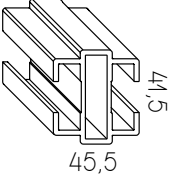
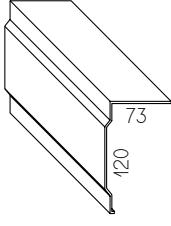
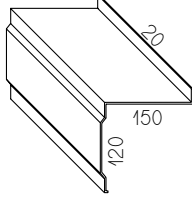
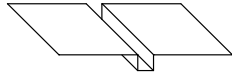
Disegno Figure Design	Descrizione Description Description	Informazioni Informations Information	Codice Article Code Code Article	U.M. Unit	Prezzo unitario Unit price Prix unitaire	Conf. std. Std. pack Cf. std
	Asta di manovra verniciata Crank handle Manivelle	Cm 100	AST0A100	Pz		10
		Cm 120	AST0A120			
		Cm 150	AST0A150			
		Cm 180	AST0A180			
		Cm 200	AST0A200			
		Cm 220	AST0A220			
		Cm 250	AST0A250			
	Terminale tmt Ø 60 2 Ogiva Terminal profile Ø 60 With 2 ogiva Barre de charge tmt ø 60 2 Trou	Cm 400	TMT4A037	Pz		10
		Cm 500	TMT5A037			
		Cm 600	TMT6A037			
		Cm 700	TMT7A037			
	Frangivento liscio ø 60 Windbreak smooth ø 60 Brise-vent lisse ø 60	Cm 400	TMT4A038	Pz		10
		Cm 500	TMT5A038			
		Cm 600	TMT6A038			
		Cm 700	TMT7A038			
	Guida singola tmt Guide single tmt Guide simple tmt	Cm 400	TMT4A016	Pz		10
		Cm 500	TMT5A016			
		Cm 600	TMT6A016			
		Cm 700	TMT7A016			
	Guida doppia tmt Guide double tmt Guide double tmt	Cm 400	TMT4A035	Pz		10
		Cm 500	TMT5A035			
		Cm 600	TMT6A035			
		Cm 700	TMT7A035			
	Tettino di protezione a soffitto Canopy of protection for ceiling Auvent de protection plafond	Cm 300	TMT3A018	Pz		10
		Cm 400	TMT4A018			
		Cm 700	TMT7A018			
	Tettino di protezione a parete Canopy of protection for wall Auvent de protection mural	Cm 400	TMT4A015	Pz		10
		Cm 500	TMT5A015			
		Cm 600	TMT6A015			
		Cm 700	TMT7A015			
	Tettino centrale Canopy central Auvent central	Cm 400	TMT4A039	Pz		10
		Cm 500	TMT5A039			
		Cm 600	TMT6A039			

TMT PLUS



TMT PLUS P/S

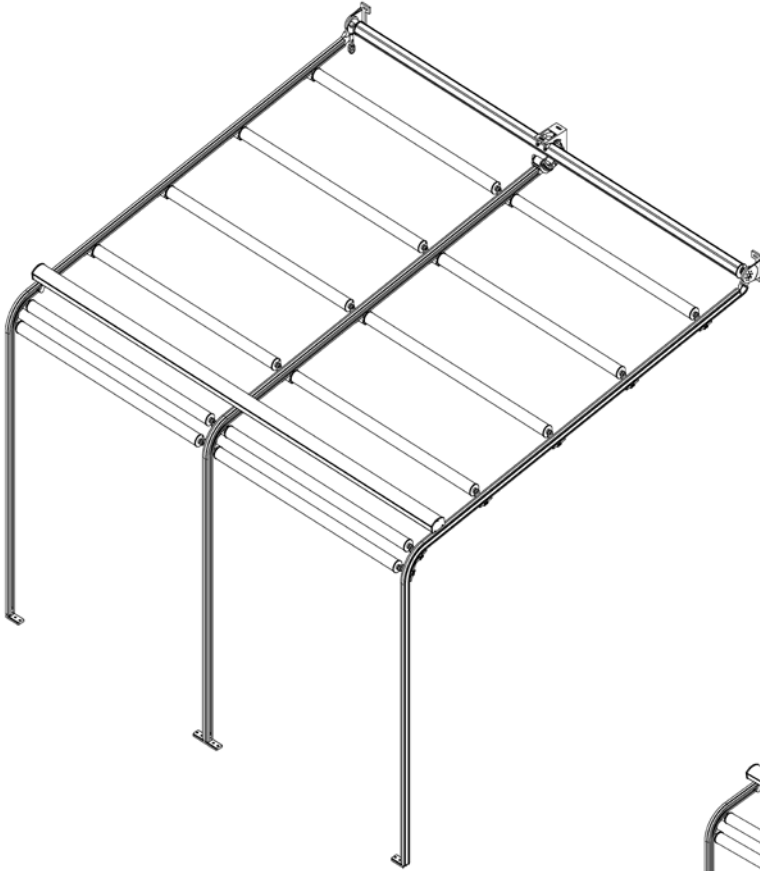

TMT PLUS B/Q



Colori di serie / Standard color / Couleurs standard



Ral
Bianco
9010





Ral
Avorio
1013

Ral
Grigio
7035

Ral
Bronzo

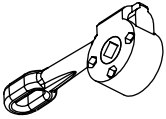
Ral
Antracite

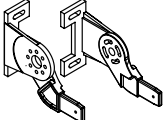
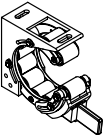
Altri colori / Another colors / Autres couleurs +20%

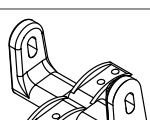
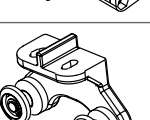
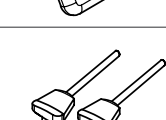
Disegno Figure Dessign	Descrizione Description Description	Informazioni Informations Information	Codice Article Code Code Article	U.M. Unit Unit price	Prezzo unitario Unit price Prix unitaire	Conf. std. Std. pack Cf. std
	Arganello 11:1 Awning gearbox 11:1 Treuil 11:1		ARG11A	Pz		25
	Molla assemblata ø 70 Spring assembled rod empty ø 70 Ressort assemblé ø 70	Cm 120 Cm 140 Cm 180	MOLLA120/70 MOLLA140/70 MOLLA180/70			10
	Staffe p/s regolabili in alluminio Adjustable bracket tmt wall / ceiling Allum. Supports réglables en aluminium		TMT0A019	Cp		10
	Supporti tmt plus P/S - B/Q con bulloneria Supports tmt plus P/S - B/Q with bolts and nuts Support mur/plafond garden et tmt plus sur barre carrée avec boulons	Zincata Inox	SG00012ZA SG00012A			10
	Supporto avvolgitore su b/q Support for winder for square bar Support enrouleur pour garden sur barre carrée		SG00007	Cp		10
	Supporto compensatore tmt plus Balance support tmt plus Compensateur tmt plus		TMTP-009A	Pz		5
	Supporto compensatore tmt plus su b/q Balance support for tmt plus on Squared bar Compensateur tmt plus b/q		TMTP-010A	Pz		5
	Supporto guida con attacco barra quadra Support for guide mount square bar Support guide avec attache barre carrée		TMTP-011A	Pz		5
	Supporto frangivento Support windbreak tmt plus Support brise-vent		TMTP-020A	Pz		20
	Supporto frangivento doppio Support windbreak double tmt plus Double support brise-vent		TMTP-019A	Pz		10
	Carrello tmt plus Trolley tmt plus Chariots tmt plus		TMTP-016A	Pz		10
	Occhiolo tmt plus Eyelet tmt plus Attache tmt plus		TMTP-018A	Pz		10
	Fermo guida Stopper for guide tmt Arrêt guide tmt	Zincata Inox	TMT00007D SG00015D			50

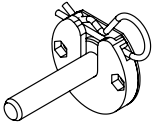
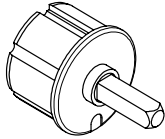
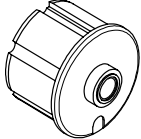
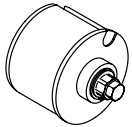
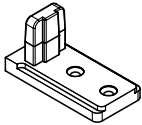
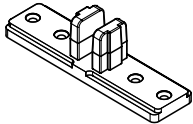
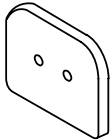
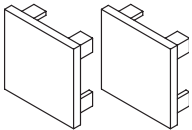
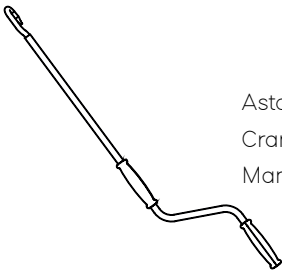
Disegno Figure Dessign	Descrizione Description Description	Informazioni Informations Information	Codice Article Code Code Article	U.M. Unit Unit	Prezzo unitario Unit price Prix unitaire	Conf. std. Std. pack Cf. std
	Piastrina in nylon con perno estraibile Plate nylon with removable pin Plaquette en nylon avec axe extraible		TNRM-040	Pz		100
	Tappo ø 70 con perno quadro 13x55 Plug with square pin 13x55 ø 70 Embout ø 70 avec axe carré 13x40		TAPPQ70-13x55	Pz		80
	Tappo con foro ø 70 Plug ø 70 with hole ø 14 Embout ø 70 avec trou ø 14		TAPF70	Pz		200
	Tappo frangivento tmt plus ø 60 Plug windbreak tmt plus ø 60 Embout brise-vent tmt plus ø 60	Zincata	TAPFRAZIN60A	Pz		200
	Piedino singolo in alluminio Leg single allum. Pied simple en aluminium		TMT0A006	Pz		100
	Piedino doppio in alluminio Led double allum. Double pied en aluminium		TMT0A012	Pz		50
	Tappi terminale con viti Plug forterminal profile with Screws Bouchons barre de charge avec vis		OPEN-160	Cp		50
	Tappi in nylon per barra quadra Nylon caps for square bar Bouchons en nylon pour barre carrée		BQC00024A	Cp		50
	Asta di manovra verniciata Crank handle Manivelle	Cm 100 Cm 120 Cm 150 Cm 180 Cm 200 Cm 220 Cm 250 Cm 300	AST0A100 AST0A120 AST0A150 AST0A180 AST0A200 AST0A220 AST0A250 AST0A300	Pz		10

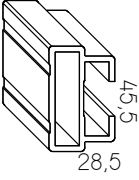
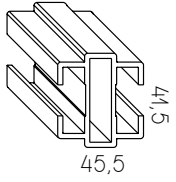
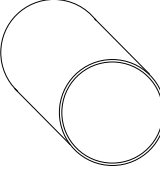
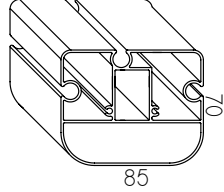
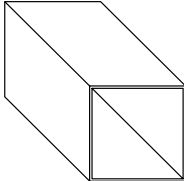
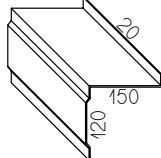
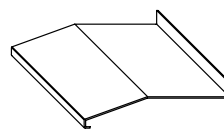
Disegno Figure Dessign	Descrizione Description Description	Informazioni Informations Information	Codice Article Code Code Article	U.M. Unit Unit price	Prezzo unitario Unit price Prix unitaire	Conf. std. Std. pack Cf. std
	Guida singola tmt Guide single tmt Guide simple tmt	Cm 400 Cm 500 Cm 600 Cm 700 1004gr/ml	TMT4A016 TMT5A016 TMT6A016 TMT7A016	Pz		10
	Guida doppia tmt Guide double tmt Guide double tmt	Cm 400 Cm 500 Cm 600 Cm 700 1290gr/ml	TMT4A035 TMT5A035 TMT6A035 TMT7A035	Pz		10
	Frangivento liscio ø 60 Windbreak smooth ø 60 Brise-vent lisse ø 60	Cm 400 Cm 500 Cm 600 Cm 700 782gr/ml	TMT4A038 TMT5A038 TMT6A038 TMT7A038	Pz		10
	Terminale tmt plus Terminal profile tmt plus Barre de charge tmt plus	Cm 400 Cm 500 Cm 600 Cm 700 2376gr/ml	M1554A003 M1555A003 M1556A003 M1557A003	Pz		10
	Barra quadra 40x40x2 in ferro Zincata e verniciata Square bar 40x40x2 iron zinc Painted Barre carrée 40x40x2 en fer galvanisé et laqué	Cm 400 Cm 500 Cm 600 Cm 700 2393gr/ml	BQC4A001 BQC5A001 BQC6A001 BQC7A001	Pz		10
	Tettino di protezione a parete Canopy of protection for wall Auvent de protection mural	Cm 400 Cm 500 Cm 600 Cm 700 1675gr/ml	TMT4A015 TMT5A015 TMT6A015 TMT7A015	Pz		10
	Tettino in alluminio piegato Roof allum. Bent Auvent en aluminium plié	Cm 400 Cm 500 Cm 600 Cm 700	SG4A016 SG5A016 SG6A016 SG7A016	Pz		10

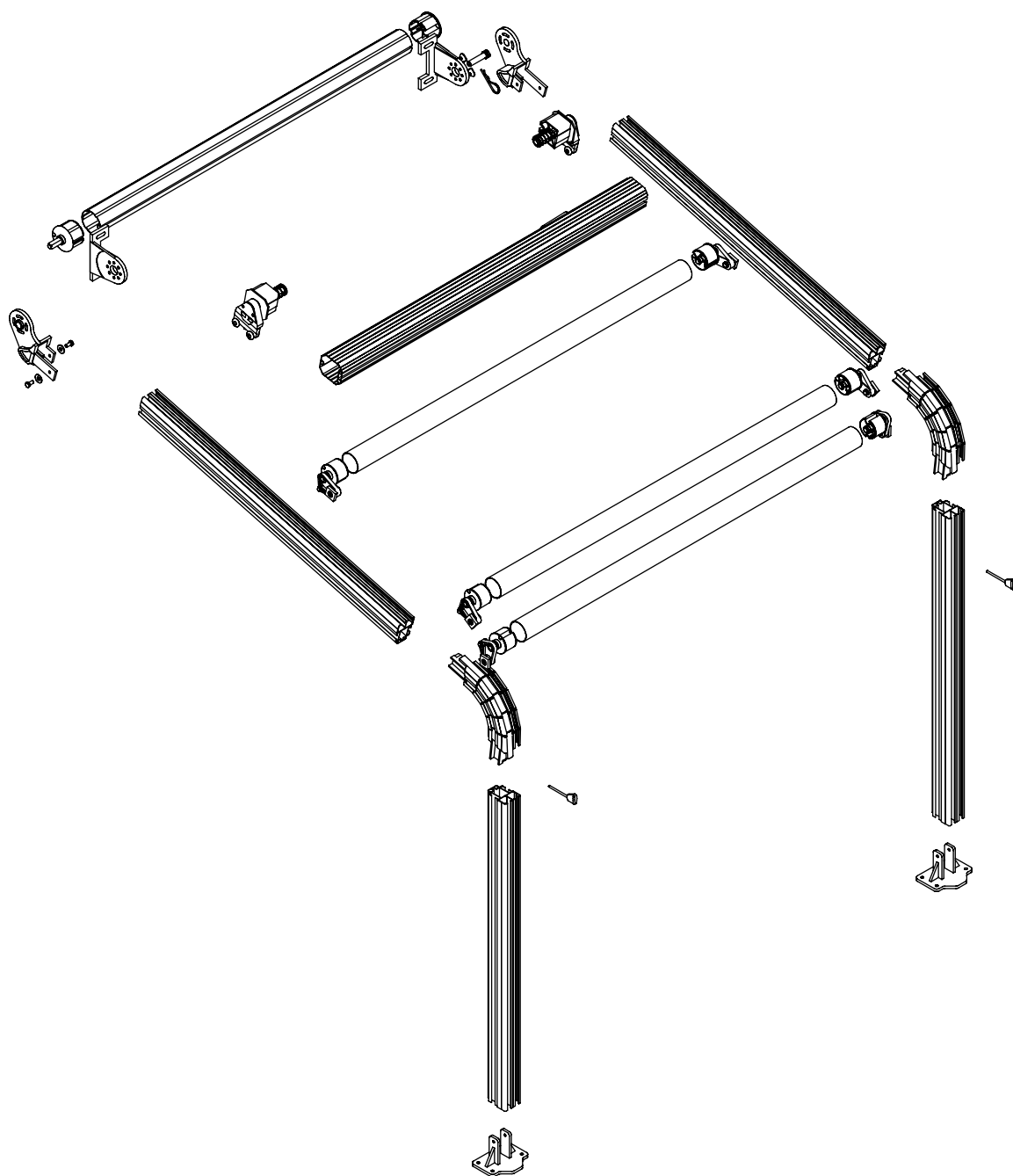

Colori di serie / Standard color / Couleurs standard







Ral
Bianco
9010

Ral
Avorio
1013

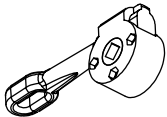
Ral
Grigio
7035

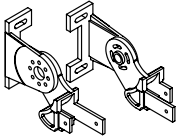
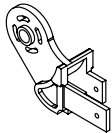
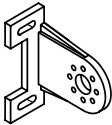
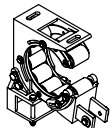
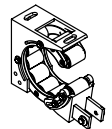
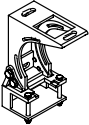
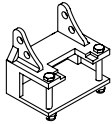
Altri colori / Another colors / Autres couleurs +20%

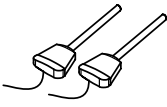
Disegno Figure Dessign	Descrizione Description Description	Informazioni Informations Information	Codice Article Code Code Article	U.M. Unit	Prezzo unitario Unit price Prix unitaire	Conf. std. Std. pack Cf. std
	Arganello 11:1 Awning gearbox 11:1 Treuil 11:1		ARG11:1A	Pz		25
	Molla assemblata ø 70 Spring assembled rod empty ø 70 Ressort assemblé ø 70	Cm 120 Cm 140 Cm 180	MOLLA120/70 MOLLA140/70 MOLLA180/70			10
	Staffe universali garden con bulloneria Bracket universal sg with Bolt stainless Supports universels garden avec boulons	Inox	SG0A010	Cp		20
	Supporto guida garden con bulloni Inox Garden guide support with stainless steel bolts Support de guide garden avec bullon. inox	Dx Sx	SG0A020 SG0A021		Pz	10
	Supporto p/s garden Support wall/ceiling garden Support mur/plafond garden		SG0A017	Pz		10
	Supporto compensatore garden su b/q Support winder garden for square bar Support compensateur garden sur barre carrée		SG04015A	Pz		5
	Supporto compensatore garden ps Support winder garden wall/ceiling Support compensateur garden p/s		SG04016A	Pz		5
	Supporti tmt plus P/S - B/Q con bulloneria Supports tmt plus P/S - B/Q with bolts and nuts Supports mur/plafond garden et tmt plus sur barre carrée avec boulons	Inox	SG00012A	Pz		10
	Inserto per supporto b/q Insert for support square bar sg Insert pour support barre carrée garden	Inox	SG00013A	Pz		20
	Curva garden Curve garden Courbe garden		SG0A012	Cp		10
	Piedino garden Leg garden Pied garden		SG0A005	Pz		20
	Supporto avvolgitore su b/q Support for winder for square bar Support enrouleur pour garden sur barre carrée		SG00007	Cp		10
	Fermo guida Stopper for guide tmt Goupille de blocage barre de charge avec axe inox	Zincata Inox	TMTP00007D SG00015D		Pz	50
	Piastrina in nylon con perno estraibile Plate nylon with removable pin Plaquette en nylon avec axe extraible		TNRM-040	Pz		100

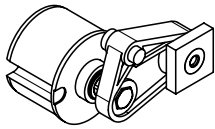
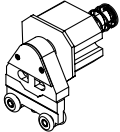
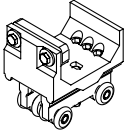
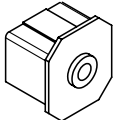
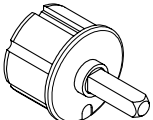
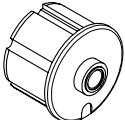
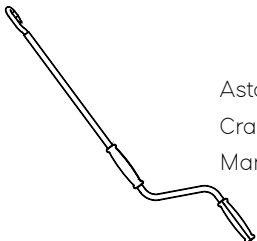
Disegno Figure Dessign	Descrizione Description Description	Informazioni Informations Information	Codice Article Code Code Article	U.M. Unit	Prezzo unitario Unit price Prix unitaire	Conf. std. Std. pack Cf. std
	Tappo frangivento garden inox Caps for windbreak with pin Stainless Embout brise-vent garden inox		SG00008A	Cp		50
	Carrello scorrevole garden Sliding trolley sg with accessories Stainless Chariot coulissant garden		SG0D001	Pz		20
	Carrello scorrevole centrale Garden Sliding trolley central sg with Accessories stainless Chariot central coulissant garden		SG0D002	Pz		10
	Tappo terminale garden Terminal plug Bouchon barre de charge garden		SG00011	Cp		100
	Tappo ø 70 con perno quadro 13x55 Plug with square pin 13x55 ø 70 Embout ø 70 avec axe carré 13x55		TAPPQ70-13x55	Pz		80
	Tappo con foro ø 70 Plug ø 70 with hole ø 14 Embout ø 70 avec trou ø 14		TAPF70	Pz		200
	Asta di manovra verniciata Crank handle Manivelle	Cm 100 Cm 120 Cm 150 Cm 180 Cm 200 Cm 220 Cm 250 Cm 300	AST0A100 AST0A120 AST0A150 AST0A180 AST0A200 AST0A220 AST0A250 AST0A300	Pz		10

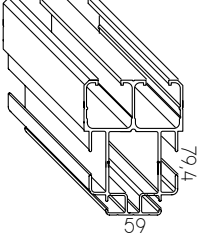
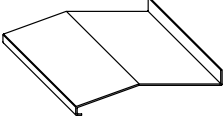
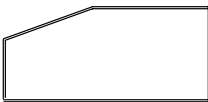
Disegno Figure Dessign	Descrizione Description Description	Informazioni Informations Information	Codice Article Code Code Article	U.M. Unit Unit price	Prezzo unitario Unit price Prix unitaire	Conf. std. Std. pack Cf. std
	Frangivento liscio ø 60 Windbreak smooth ø 60 Brise-vent lisse ø 60	Cm 400	TMT4A038	Pz		10
		Cm 500	TMT5A038			
		Cm 600	TMT6A038			
		Cm 700	TMT7A038			
		782gr/ml				
	Terminale garden Terminal profile garden Barre de charge garden	Cm 400	SG4A013	Pz		10
		Cm 500	SG5A013			
		Cm 600	SG6A013			
		Cm 700	SG7A013			
		1608gr/ml				
	Guida garden Guide garden Guide garden	Cm 500	SG5A014	Pz		10
		Cm 600	SG6A014			
		Cm 700	SG7A014			
		1787gr/ml				
	Tettino in alluminio piegato Roof allum. Bent Auvent en aluminium plié	Cm 400	SG4A016	Pz		10
		Cm 500	SG5A016			
		Cm 600	SG6A016			
		Cm 700	SG7A016			
	Tappi tettino in alluminio piegato Folded aluminum roof caps Chapeaux de toit en aluminium plié		SGT0A001	Pz		10

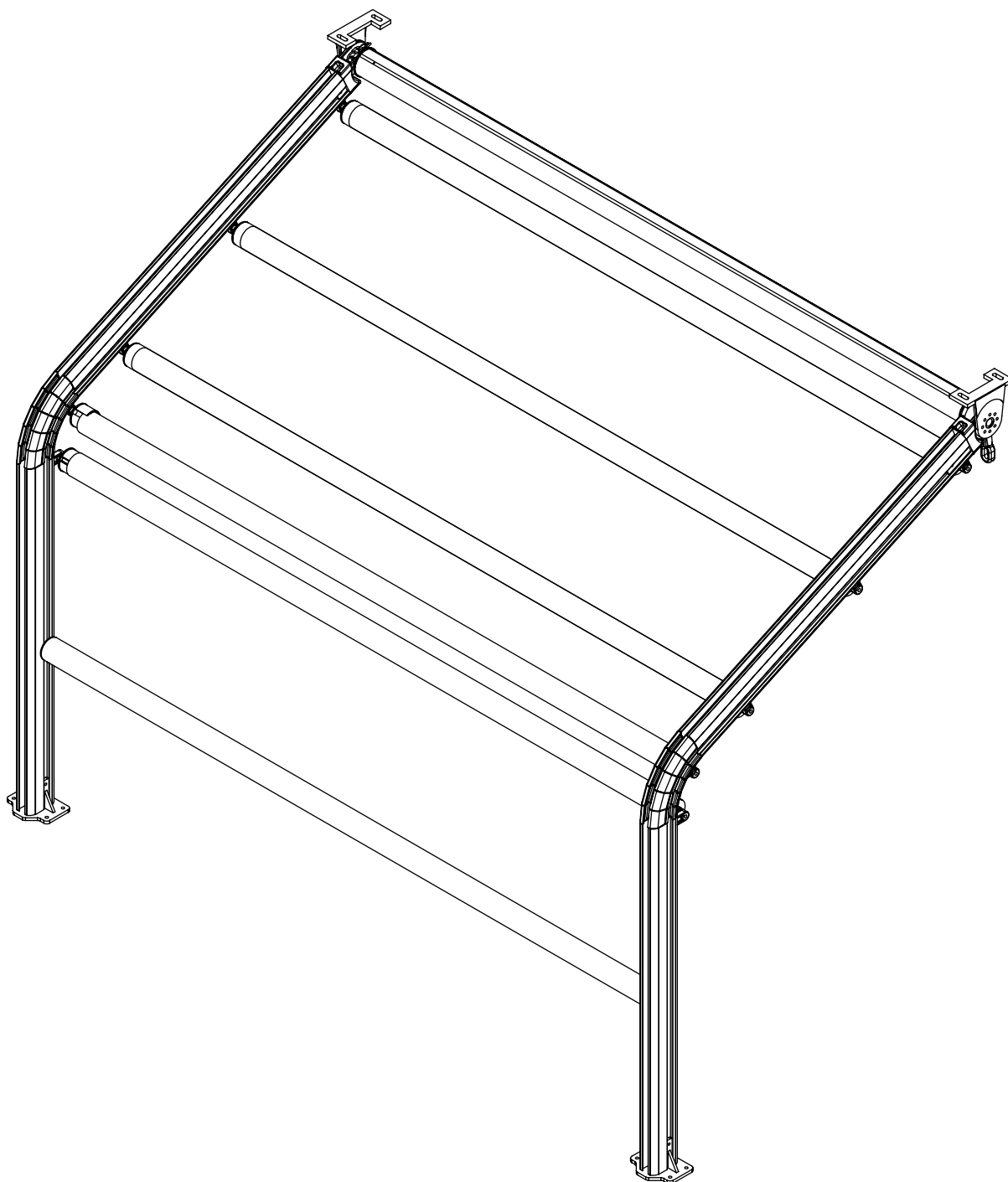



Colori di serie / Standard color / Couleurs standard



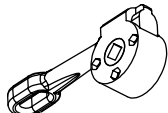

Ral
Bianco
9010

Ral
Avorio
1013

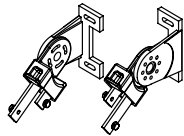
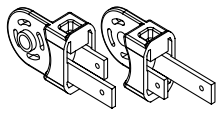
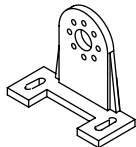
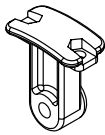
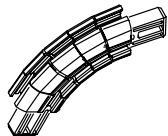
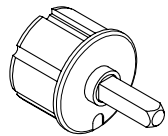
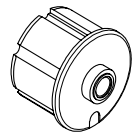
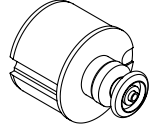
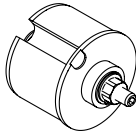
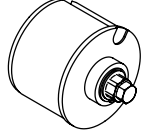
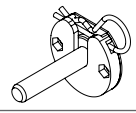
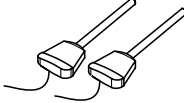
Altri colori / Another colors / Autres couleurs +20%

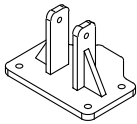
Disegno Figure Dessign	Descrizione Description Description	Informazioni Informations Information	Codice Article Code Code Article	U.M. Unit	Prezzo unitario Unit price Prix unitaire	Conf. std. Std. pack Cf. std
	Arganello 11:1 Awning gearbox 11:1 Treuil 11:1		ARG11A	Pz		25
	Molla assemblata ø 70 Spring assembled rod empty ø 70 Ressort assemblé ø 70	Cm 120 Cm 140 Cm 180	MOLLA120/70 MOLLA140/70 MOLLA180/70	Pz		10
	Staffe universali garden con bulloneria Bracket universal sg with Bolt stainless Supports universels garden avec boulons	Inox	GRN2-006	Cp		20
	Supporto guida garden dx con bullon. Inox Support guide right with stainless bolt Support de guide garden droit avec bullon. inox Supporto guida garden sx con bullon. Inox Support guide left with stainless bolt Support de guide garden gauche avec Bullon. inox		GRN2-011 GRN2-010	Pz		10
	Supporto p/s garden Support wall/ceiling garden Support mur/plafond garden		SG0A017	Pz		10
	Supporto frangivento con bullon. Support windbreak with bolts Support brise-vent		GRN2-013	Pz		100
	Curva new garden Curve new garden Courbe new garden		GRN2-007	Pz		10
	Tappo ø 70 con perno quadro 13x55 Plug with square pin 13x55 ø 70 Embout ø 70 avec axe carré 13x55		TAPPQ70-13x55	Pz		80
	Tappo con foro ø 70 Plug ø 70 with hole ø 14 Embout ø 70 avec trou ø 14		TAPF70	Pz		200
	Calotta scorrevole ø 60 Plug sliding ø 60 Embout coulissant ø 60	Inox	TAPSCORINOXA	Pz		100
	Calotta perno filettato ø 60 Plug threaded pin ø 60 Embout axe fileté ø 60	Inox	TMT000012A	Pz		100
	Calotta rompitrattra ø 60 (Fisso) con perno Plug windbreak ø 60 (Fixed) with pin Embout brise-vent ø 60 (Fixe) avec axe	Zincata	TAPFRAZIN60A	Pz		100
	Piastrina in nylon con perno estraibile Plate nylon with removable pin Plaquette en nylon avec axe extraible		PES0005	Pz		100
	Fermo guida Stopper for guide tmt Arrêt guide	Inox	SG00015D	Pz		50

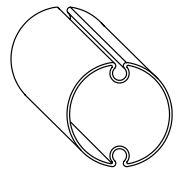
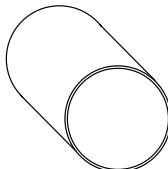
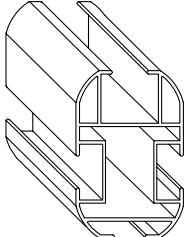
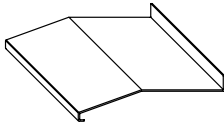
Disegno Figure Dessign	Descrizione Description Description	Informazioni Informations Information	Codice Article Code Code Article	U.M. Unit Unit price	Prezzo unitario Unit price Prix unitaire	Conf. std. Std. pack Cf. std
	Piedino new garden Leg new garden Pied garden		GRN2-012	Pz		20
	Asta di manovra verniciata Crank handle Manivelle	Cm 100 Cm 120 Cm 150 Cm 180 Cm 200 Cm 220 Cm 250 Cm 300	AST0A100 AST0A120 AST0A150 AST0A180 AST0A200 AST0A200 AST0A250 AST0A300	Pz		10
	Terminale tmt Ø 60 2 Ogiva Terminal profile Ø 60 With 2 ogive Barre de charge tmt ø 60 2 Trous	Cm 400 Cm 500 Cm 600 Cm 700 959gr/ml	TMT4A037 TMT5A037 TMT6A037 TMT7A037	Pz		10
	Frangivento liscio ø 60 Windbreak smooth ø 60 Brise-vent lisse ø 60	Cm 400 Cm 500 Cm 600 Cm 700 782gr/ml	TMT4A038 TMT5A038 TMT6A038 TMT7A038	Pz		10
	Guida new garden Guide new garden Guide new garden	Cm 500 Cm 600 Cm 700 2259gr/ml	GRN5A001 GRN6A001 GRN7A001	Pz		10
	Tettino in alluminio piegato Roof allum. Bent Auvent en aluminium plié	Cm 400 Cm 500 Cm 600 Cm 700	SG4A016 SG5A016 SG6A016 SG7A016	Pz		10

Note

A large rectangular area with horizontal dotted lines, intended for writing notes.

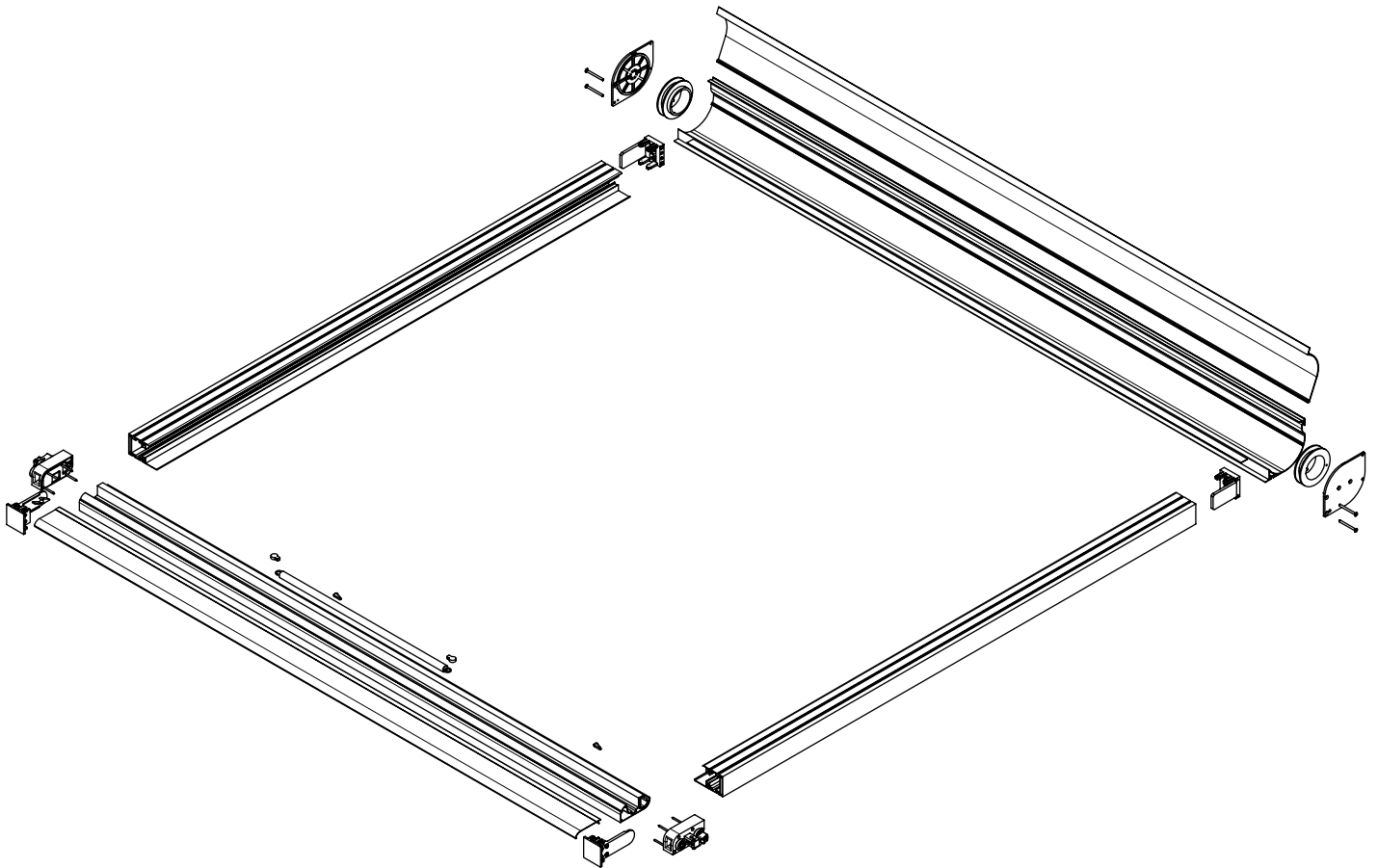

Colori di serie / Standard color / Couleurs standard



Ral
Bianco
9010

Ral
Avorio
1013

Ral
Grigio
7035

Ral
Marrone
8017

Altri colori / Another colors / Autres couleurs +20%

Disegno Figure Dessign	Descrizione Description Description	Informazioni Informations Information	Codice Article Code Code Article	U.M. Unit Unit	Prezzo unitario Unit price Prix unitaire	Conf. std. Std. pack Cf. std
	Tappi cassonetto raffaello con inserti superiori guida Plugs box insert media guide Bouchons coffre raffaello avec inserts supérieurs guide		RAFF0A001	Cp	€	5
	Tappi inferiori guida con aggancio Plugs bottom guide with hook Bouchons inférieurs avec Accrochage		RAFF0A002	Cp	€	5
	Puleggia Ø 85 Pulley Ø 85 Poulie Ø 85		RAFF0A004	Cp	€	5
	Kit registrazione cavetto con tappi Terminale Kit recorder with cable stoppers Kit enregistrement cable avec Bouchons barre de charge		RAFF0A005	Pz	€	5
	Molla terminale raffaello cm.94 Spring terminal profile raffaello Cm.94 Ressort barre de charge raffaello 94 cm	Cm 94	RAFF0A007	Pz	€	5
	Tappo Ø 85 Con foro Ø 14 Plug Ø 85 with hole Ø 14 Embout Ø 85 avec trou		TAPF85	Pz	€	80
	Supporti cassonetto p/s Supports box wall/ceiling Supports coffre mur/plafond		RAFF0A008	Cp	€	5
	Piedino per guida (fisso) leg for guide(fixed) Pied pour guide (fixe)		RAFF0A010	Pz	€	5
	Piedino regolabile per guida Leg for guide adjustable Pied réglable pour guide		OPEN-060A	Pz	€	5
	Piedino inferiore e innesto superiore Gamba Lower feet and upper grip Leg Pied inférieur et support supérieur jambe		RAFF0A009	Pz	€	5
	Innesto traversa Cross-member coupling Couplage de traverse		E095-109	Pz	€	10
	Cordino Rope Cordon		GIO.CORDA	MI	€	250
	Kit RAFFAELLO Completo Complete RAFFAELLO kit Kit complet RAFFAELLO		KIT.RAFFA	Pz	€	1

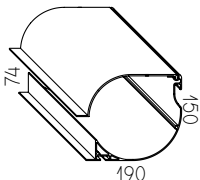
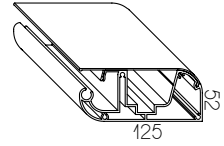
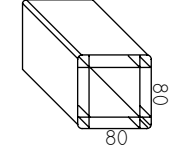
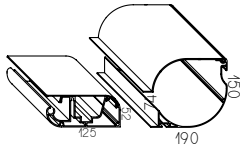
Disegno Figure Dessign	Descrizione Description Description	Informazioni Informations Information	Codice Article Code Code Article	U.M. Unit Unit	Prezzo unitario Unit price Prix unitaire	Conf. std. Std. pack Cf. std
	Cassonetto raffaello	Cm 400	CASSRF4A	Pz		10
	Box raffaello	Cm 500	CASSRF5A			
	Coffre raffaello	Cm 600	CASSRF6A			
		4284gr/ml				
	Guida raffaello	Cm 400	GUIRF4A	Pz		10
	Guide raffaello	Cm 500	GUIRF5A			
	Guide raffaello	Cm 600	GUIRF6A			
		2760gr/ml				
	Terminale raffaello con profilo Di chiusura	Cm 400	TERMRF4A	Pz		10
	Terminal profile raffaello	Cm 500	TERMRF5A			
	With profile of closure	Cm 600	TERMRF6A			
	Barre de charge raffaello avec profil de fermeture	3496gr/ml				
	Profilo traversa e piede 80x80	Cm 500	E0955A001	Pz		10
	Profile cross 80x80	Cm 700	E0957A001			
	Profil traverse et pied 80x80	2708gr/ml				
	Kit cassonetto e Terminale	Cm 400	KIT-CASSRF4A	Pz		10
	Box kit and Terminal	Cm 500	KIT-CASSRF5A			
	Coffret kit et Borne	Cm 600	KIT-CASSRF6A			
		7780gr/ml				

Note

A large rectangular area with horizontal dotted lines, intended for writing notes.

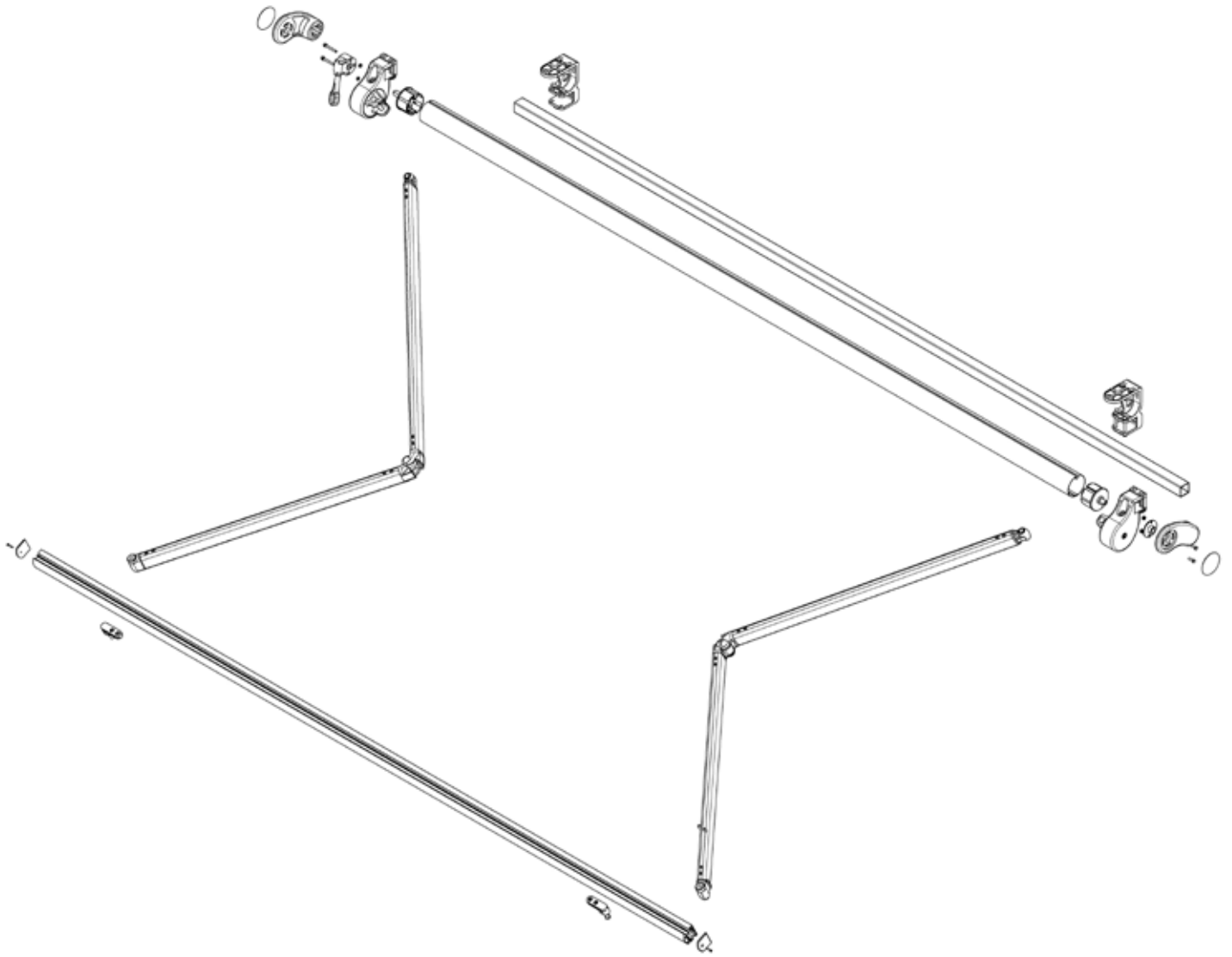

Colori di serie / Standard color / Couleurs standard



Ral
Bianco
9010



Ral
Avorio
1013

Ral
Marrone
8017

Ral
Grigio
7035

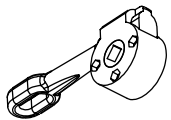
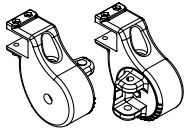
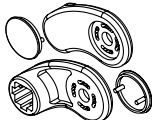
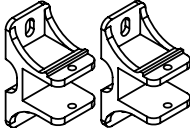
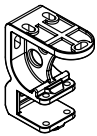
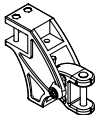
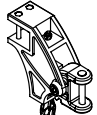
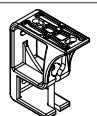
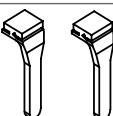
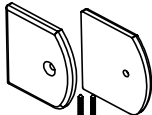

Ral
Antracite

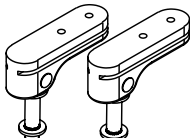
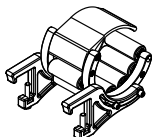
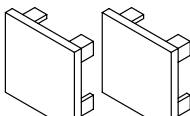
Altri colori / Another colors / Autres couleurs +20%

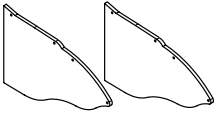
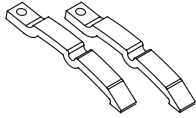
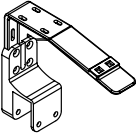
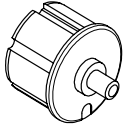
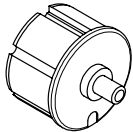
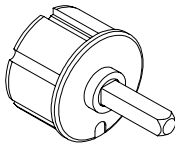
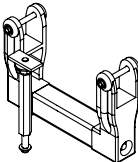
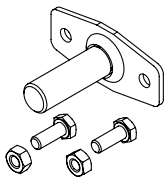
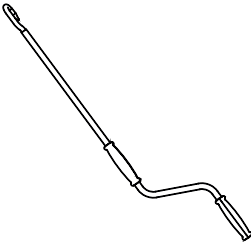
Disegno Figure Dessign	Descrizione Description Description	Informazioni Informations Information	Codice Article Code Code Article	U.M. Unit	Prezzo unitario Unit price Prix unitaire	Conf. std. Std. pack Cf. std
	Arganello 11:1 Awning gearbox 11:1 Treuil 11:1		ARG11A	Pz		25
	Supporto braccio lux c90 Support for arm lux c90 Support bras lux c90		LUX0001/90A	Cp		10
	Supporto avvolgitore lux/compact Support winder b4c lux/compact Support enrouleur b4c lux/compact		LUX0002A	Cp		10
	Supporto simmetrico Support symmetrical Support symétrique		BQ40-056A	Cp		10
	Supporto universale b/q lux Support universal square bar lux Support universel barre carrée lux		LUX0003A	Cp		10
	Supporto braccio v 91 Support arm v 91 Support bras réglable v 91		SUPV91A	Cp		10
	Supporto braccio regolabile v 91r Support arm adjustable v 91r Support bras réglable v 91r		SUPV91REG-A	Cp		10
	Supporto universale barra quadra v10 Bracket universal square bar v10 Support universel barre carrée v10		SUPPS/V10A	Cp		20
	Scivolo raccoglibraccio in nylon Slide tray arms Goulotte ramasse-bras en nylon		SCIV00001A	Cp		100
	Tappi terminale 31266 con viti Caps for terminal profile with Screws Bouchons barre de charge 31266 avec vis		EUR0A025	Cp		50
	Tappi terminale alto con viti Caps for terminal profile with Screws Bouchons barre de charge 31266 avec vis		BQ40-006	Cp		50
	Scivolo snodato in alluminio Articulated slide lux Goulotte barre de charge en alum.		LUX0004A	Cp		25
	Supporto compensatore Balance support Support compensateur		BQC0A019	Pz		10
	Tappi in nylon per barra quadra Nylon caps for square bar Bouchons en nylon pour barre carrée		BQC00024A	Cp		50

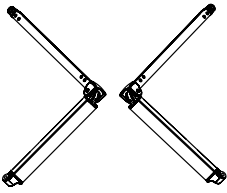
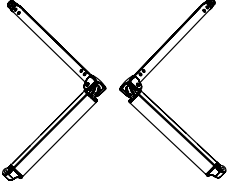
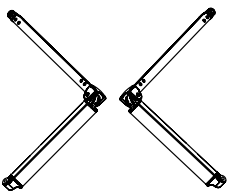
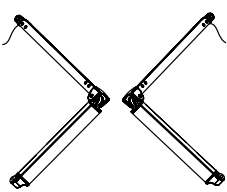
Disegno Figure Dessign	Descrizione Description Description	Informazioni Informations Information	Codice Article Code Code Article	U.M. Unit	Prezzo unitario Unit price Prix unitable	Conf. std. Std. pack Cf. std
	Tappi in nylon per tettino estruso Caps for roof extruded nylon Bouchons en nylon pour auvent extrudé		BQC0A029	Cp		20
	Stecchette per tettino Cues for roof Branchettes pour auvent		BQA0A029	Cp		10
	Staffe intermedie regolabili per tettino Intermediate bracket for roof Square bar Supports intermediaires réglables pour auvent		BQC0A039	Pz		10
	Tappo d.70 Con perno tondo 14x20 Plug with round pin dia 70 14x20 Embout ø 70 avec axe rond 14x20		TAPPT70	Cp		80
	Tappo d.78 Con perno tondo 14x20 Plug with round pin dia 78 14x20 Embout ø 78 avec axe rond 14x20		TAPPT78	Cp		80
	Tappo con foro Plug with hole Embout avec trou	Ø 70 Ø 78	TAPF70 TAPF78	Pz		200
	Tappo Ø 78 Con perno quadro Plug ø 78 with square pin Embout ø 78 avec axe carré 13x40	13x25 13x40 13x48 13x55 13x70	TAPPQ78-13x25 TAPPQ78-13x40 TAPPQ78-13x48 TAPPQ78-13x55 TAPPQ78-13x70	Pz		20
	Kit supporto bracci incrociati Kit support with cross arms Kit support bras croisés		BQC0A018	Pz		5
	PIASTRINA CON PERNO-PLATE WITH PIN-PLAQUETTE AVEC AXE Senza bulloni e dadi Without bolts and nuts Sans boulons et écrous Con bulloni e dadi With bolts and nuts Avec Boulons et écrous	13x40 13x75 13x40 13x75	PCP00001 PCP00002 PCP00003 PCP00004	Pz		100
	Asta di manovra verniciata Crank handle Manivelle	Cm 100 Cm 120 Cm 150 Cm 180 Cm 200 Cm 220 Cm 250 Cm 300	AST0A100 AST0A120 AST0A150 AST0A180 AST0A200 AST0A200 AST0A250 AST0A300	Pz		10

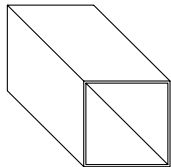
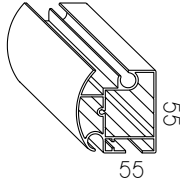
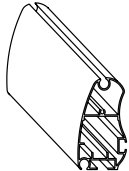
Disegno Figure Dessign	Descrizione Description Description	Informazioni Informations Information	Codice Article Code Code Article	U.M. Unit	Prezzo unitario Unit price Prix unitaire	Conf. std. Std. pack Cf. std
	Bracci a catena Arms with chain Bras à chaîne	Cm 160	BRA0A160	Cp		10
		Cm 185	BRA0A185			
		Cm 210	BRA0A210			
		Cm 235	BRA0A235			
		Cm 260	BRA0A260			
		Cm 285	BRA0A285			
		Cm 310	BRA0A310			
		Cm 440	BRA0A410			
	Bracci a cavetto Arms with cable Bras à câble	Cm 160	BQCCAV0A160	Cp		10
		Cm 185	BQCCAV0A185			
		Cm 210	BQCCAV0A210			
		Cm 235	BQCCAV0A235			
		Cm 260	BQCCAV0A260			
		Cm 285	BQCCAV0A285			
		Cm 310	BQCCAV0A310			
		Cm 440	BQCCAV0A410			
	Bracci a catena twister Arms with chain twister Bras à chaîne twister	Cm 160	TWS0A160	Cp		10
		Cm 185	TWS0A185			
		Cm 210	TWS0A210			
		Cm 235	TWS0A235			
		Cm 260	TWS0A260			
		Cm 285	TWS0A285			
		Cm 310	TWS0A310			
		Cm 440	TWS0A410			
	Bracci led a catena Arms with chain Bras à chaîne	Cm 160	BQC-LED-160A	Cp		10
		Cm 185	BQC-LED-185A			
		Cm 210	BQC-LED-210A			
		Cm 235	BQC-LED-235A			
		Cm 260	BQC-LED-260A			
		Cm 285	BQC-LED-285A			
		Cm 310	BQC-LED-310A			
		Cm 440	BQC-LED-410A			

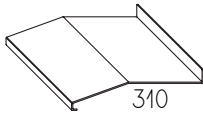
Disegno Figure Dessign	Descrizione Description Description	Informazioni Informations Information	Codice Article Code Code Article	U.M. Unit	Prezzo unitario Unit price Prix unitaire	Conf. std. Std. pack Cf. std
	Barra quadra 40x40x2 in ferro Zincata e verniciata Square bar 40x40x2 iron zinc Painted Barre carrée 40x40x2 en fer galvanisé et peint	Cm 400	BQC4A001	Pz		10
		Cm 500	BQC5A001			
		Cm 600	BQC6A001			
		Cm 700	BQC7A001			
		2393gr/ml				
	Terminale 31266 Terminal profile 31266 Barre de charge 31266	Cm 400	BQC4A030	Pz		10
		Cm 500	BQC5A030			
		Cm 600	BQC6A030			
		Cm 700	BQC7A030			
		1276gr/ml				
	Terminale alto Terminal profile Barre de charge	Cm 400	BQC4A040	Pz		10
		Cm 500	BQC5A040			
		Cm 600	BQC6A040			
		Cm 700	BQC7A040			
		1494gr/ml				
	Tettino estruso Roof extruded Auvent extrudé	Cm 400	BQC405A1ES	Pz		10
		Cm 500	BQC505A1ES			
		Cm 600	BQC605A1ES			
		Cm 700	BQC705A1ES			
		1835gr/ml				
	Tettino piegato Roof allum. Bent Auvent plié	Cm 300	BQC3A1	Pz		10
		Cm 400	BQC4A1			
		Cm 500	BQC5A1			
		Cm 600	BQC6A1			

Note

A large rectangular area with horizontal dotted lines, intended for writing notes.

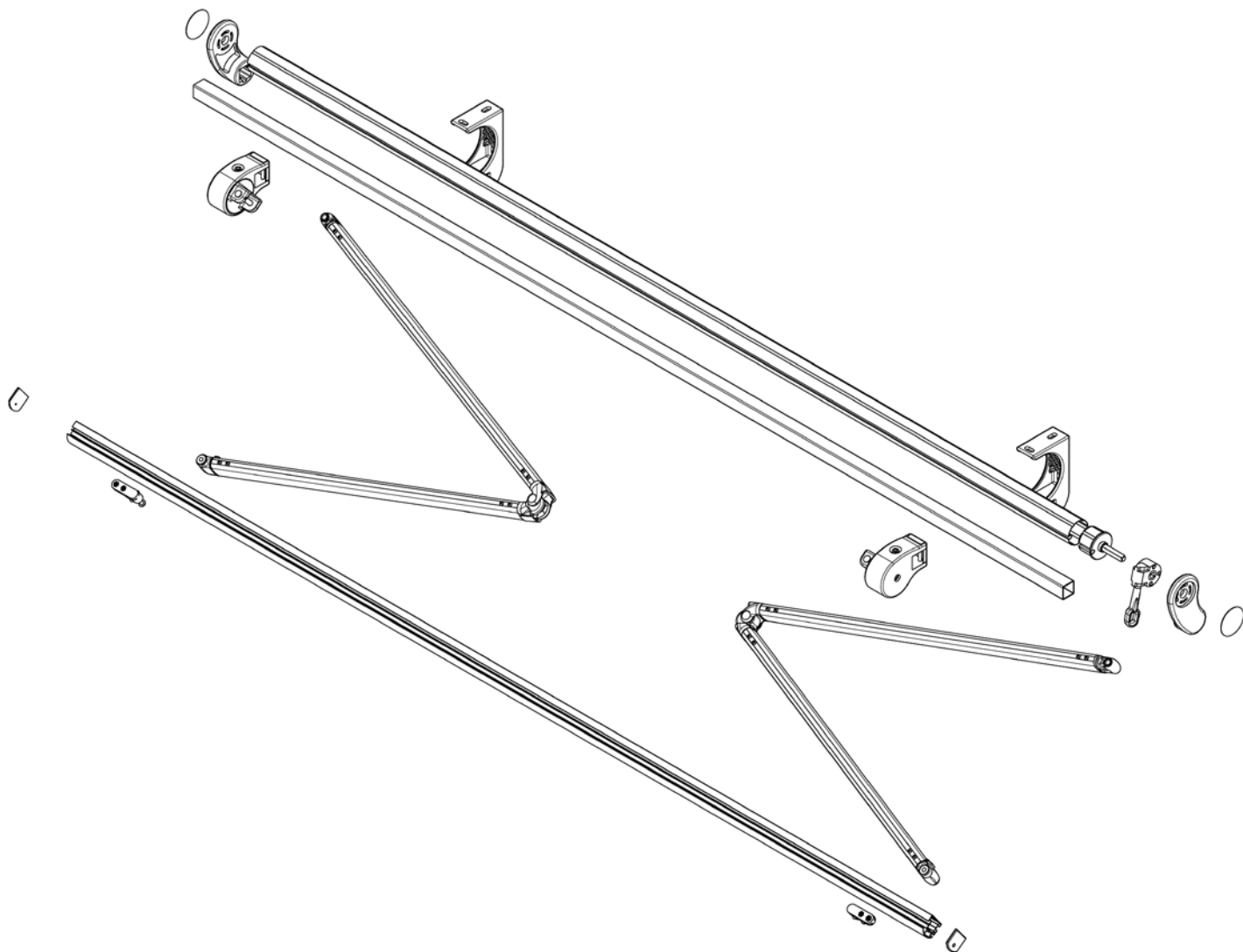

Colori di serie / Standard color / Couleurs standard



Ral
Bianco
9010

Ral
Antracite

Ral
Avorio
1013

Ral
Marrone
8017

Ral
Grigio
7035

Altri colori / Another colors / Autres couleurs +20%

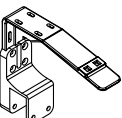
Disegno Figure Dessign	Descrizione Description Description	Informazioni Informations Information	Codice Article Code Code Article	U.M. Unit	Prezzo unitario Unit price Prix unitaire	Conf. std. Std. pack Cf. std
	Arganello 11:1 Awning gearbox 11:1 Treuil 11:1		ARG11:1A	Pz		25
	Supporto braccio compact C90 Support for arm compact C90 Support bras compact c90		COMP0002/90	Cp		10
	Supporto avvolgitore lux/compact Support winder b4c lux/compact Support enrouleur b4c lux/compact		LUX0002A	Cp		10
	Supporto simmetrico Support symmetrical Support symétrique		BQ40-056A	Cp		10
	Staffe parete soffitto b4c compact Bracket wall/ceiling compact Supports mur/plafond b4c compact		COMP0001	Cp		10
	Supporto braccio v 91 Support arm v 91 Support bras réglable v 91		SUPV91A	Cp		10
	Supporto braccio regolabile v 91r Support arm adjustable v 91r Support bras réglable v 91r		SUPV91REG-A	Cp		10
	Supporto compensatore Balance support for b4c compact Support compensateur		COMP0004A	Pz		10
	Scivolo snodato in alluminio Articulated slide lux Goulotte barre de charge		LUX0004A	Cp		25
	Scivolo raccoglibraccio in nylon Slide tray arms Goulotte ramasse-bras en nylon		SCIV00001A	Cp		100
	Tappi terminale 31266 con viti Caps for terminal profile with Screws Bouchons barre de charge 31266 avec vis		EUR0A025	Cp		50
	Tappi in nylon per tettino estruso Caps for roof extruded nylon Bouchons en nylon pour auvent extrudé		BQC0A029	Cp		20
	Stecchette per tettino Cues for roof Branchettes pour auvent extrudé		BQA0A029	Cp		10
	Tappi terminale alto con viti Caps for terminal profile with Screws Bouchons barre de charge avec vis		BQ40-006	Cp		50
	Staffe intermedie regolabili per tettino Intermediate bracket for roof Square bar Support intermediaire pour auvent sur barre carrée		BQC0A039	Pz		10

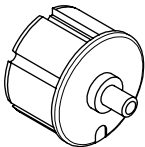
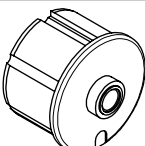
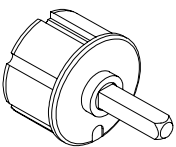
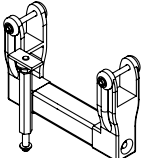
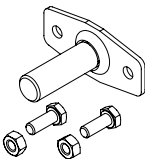
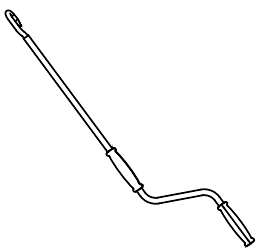
Disegno Figure Dessign	Descrizione Description Description	Informazioni Informations Information	Codice Article Code Code Article	U.M. Unit Unit price	Prezzo unitario Unit price Prix unitaire	Conf. std. Std. pack Cf. std
	Tappo perno tondo ø 70 Plug with round pin ø 70 Embout avec axe rond ø 70	ø 70	TAPPT70	Pz		80
	Tappo ø 78 con perno tondo 14x20 Plug with round pin ø 78 14x20 Embout avec axe rond ø 78	ø 78	TAPPT78			
	Tappo con foro Plug with hole Embout avec trou	ø 70	TAPF70	Pz		200
		ø 78	TAPF78			
		13x25	TAPPQ78-13x25	Pz		20
		13x40	TAPPQ78-13x40			
		13x48	TAPPQ78-13x48			
		13x55	TAPPQ78-13x55			
		13x70	TAPPQ78-13x70			
	Kit supporto bracci incrociati Kit support with cross arms Kit support bras croisés		BQC0A018	Pz		5
	PIASTRINA CON PERNO-PLATE WITH PIN-PLAQUETTE AVEC AXE			Pz		100
	Senza bulloni e dadi Without bolts and nuts Sans boulons et écrous	13x40	PCP00001			
	Con bulloni e dadi With bolts and nuts Avec Boulons et écrous	13x75	PCP00002			
		13x40	PCP00003			
		13x75	PCP00004			
	Asta di manovra verniciata Crank handle Manivelle	Cm 100	AST0A100	Pz		10
		Cm 120	AST0A120			
		Cm 150	AST0A150			
		Cm 180	AST0A180			
		Cm 200	AST0A200			
		Cm 220	AST0A200			
		Cm 250	AST0A250			
	Cm 300	AST0A300				

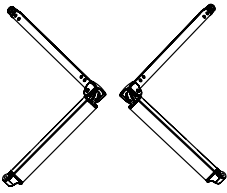
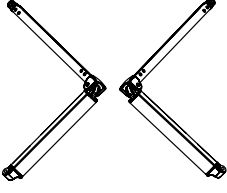
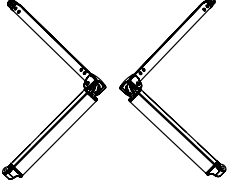
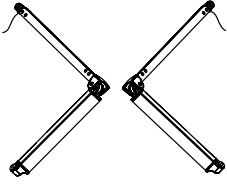
Disegno Figure Dessign	Descrizione Description Description	Informazioni Informations Information	Codice Article Code Code Article	U.M. Unit	Prezzo unitario Unit price Prix unitable	Conf. std. Std. pack Cf. std
	Bracci a catena Arms with chain Bras à chaîne	Cm 160	BRA0A160	Cp		10
		Cm 185	BRA0A185			
		Cm 210	BRA0A210			
		Cm 235	BRA0A235			
		Cm 260	BRA0A260			
		Cm 285	BRA0A285			
		Cm 310	BRA0A310			
		Cm 360	BRA0A360			
	Bracci a cavetto Arms with cable Bras à câble	Cm 160	BQCCAV0A160	Cp		10
		Cm 185	BQCCAV0A185			
		Cm 210	BQCCAV0A210			
		Cm 235	BQCCAV0A235			
		Cm 260	BQCCAV0A260			
		Cm 285	BQCCAV0A285			
		Cm 310	BQCCAV0A310			
		Cm 360	BQCCAV0A360			
	Bracci a catena twister Arms with chain twister Bras à chaîne twister	Cm 160	TWS0A160	Cp		10
		Cm 185	TWS0A185			
		Cm 210	TWS0A210			
		Cm 235	TWS0A235			
		Cm 260	TWS0A260			
		Cm 285	TWS0A285			
		Cm 310	TWS0A310			
		Cm 360	TWS0A360			
	Bracci led a catena Arms with chain Bras à chaîne	Cm 160	BQC-LED-160A	Cp		10
		Cm 185	BQC-LED-185A			
		Cm 210	BQC-LED-210A			
		Cm 235	BQC-LED-235A			
		Cm 260	BQC-LED-260A			
		Cm 285	BQC-LED-285A			
		Cm 310	BQC-LED-310A			
		Cm 360	BQC-LED-360A			
Cm 410	BQC-LED-410A					

Disegno Figure Dessign	Descrizione Description Description	Informazioni Informations Information	Codice Article Code Code Article	U.M. Unit Unit	Prezzo unitario Unit price Prix unitaire	Conf. std. Std. pack Cf. std
------------------------------	---	---	--	----------------------	--	------------------------------------

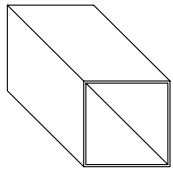

Barra quadra 40x40x2 in ferro
Zincata e verniciata
Square bar 40x40x2 iron zinc
Painted
Barre carrée 40x40x2 en fer galvanisé et peint

Cm 400 BQC4A001
Cm 500 BQC5A001
Cm 600 BQC6A001
Cm 700 BQC7A001
2393gr/ml

Pz

10

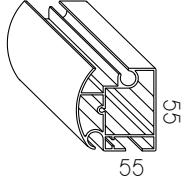

Terminale 31266
Terminal profile 31266
Barre de charge 31266

Cm 400 BQC4A030
Cm 500 BQC5A030
Cm 600 BQC6A030
Cm 700 BQC7A030
1276gr/ml

Pz

10

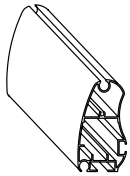

Terminale alto
Terminal profile
Barre de charge

Cm 400 BQC4A040
Cm 500 BQC5A040
Cm 600 BQC6A040
Cm 700 BQC7A040
1494gr/ml

Pz

10

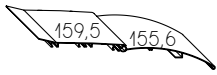

Tettino estruso
Roof extruded
Auvent extrudé

Cm 400 BQC405A1ES
Cm 500 BQC505A1ES
Cm 600 BQC605A1ES
Cm 700 BQC705A1ES
1835gr/ml

Pz

10

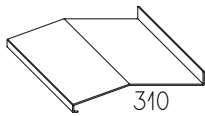

Tettino piegato
Roof allum. Bent
Auvent plié

Cm 300 BQC3A1
Cm 400 BQC4A1
Cm 500 BQC5A1
Cm 600 BQC6A1

Pz

10

ATTENZIONE
LA BQC COMPACT CASSONATA E' REALIZZATA CON GLI STESSI ACCESSORI DELLA BQC COMPACT
ATTENTION
BQC THE BOX COMPACT AND MADE WITH THE SAME ACCESSORIES BQC COMPACT
ATTENTION
LE BQC COMPACT AVEC COFFRE EST FAIT AVEC LES MÊMES ACCESSOIRES DU BQC COMPACT

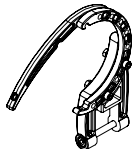

Supporto semicircolare per cassetto compact
Support semicircular for box Compact
Support semicirculaire pour coffre Compact

COMP0005A

Pz

10

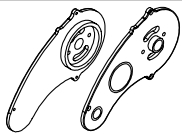

Tappi cassetto completi di regolazione
Caps for box with adjustment bolts
Bouchons coffre complets de réglage

COMP0006A

Cp

10

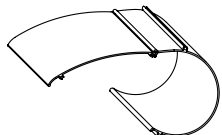

Cassetto compact
Box compact
Coffre compact

Cm 400 CASSCMP4A
Cm 500 CASSCMP5A
Cm 600 CASSCMP6A
Cm 700 CASSCMP7A

Pz

5

Note

A large rectangular area with horizontal dotted lines, intended for writing notes.

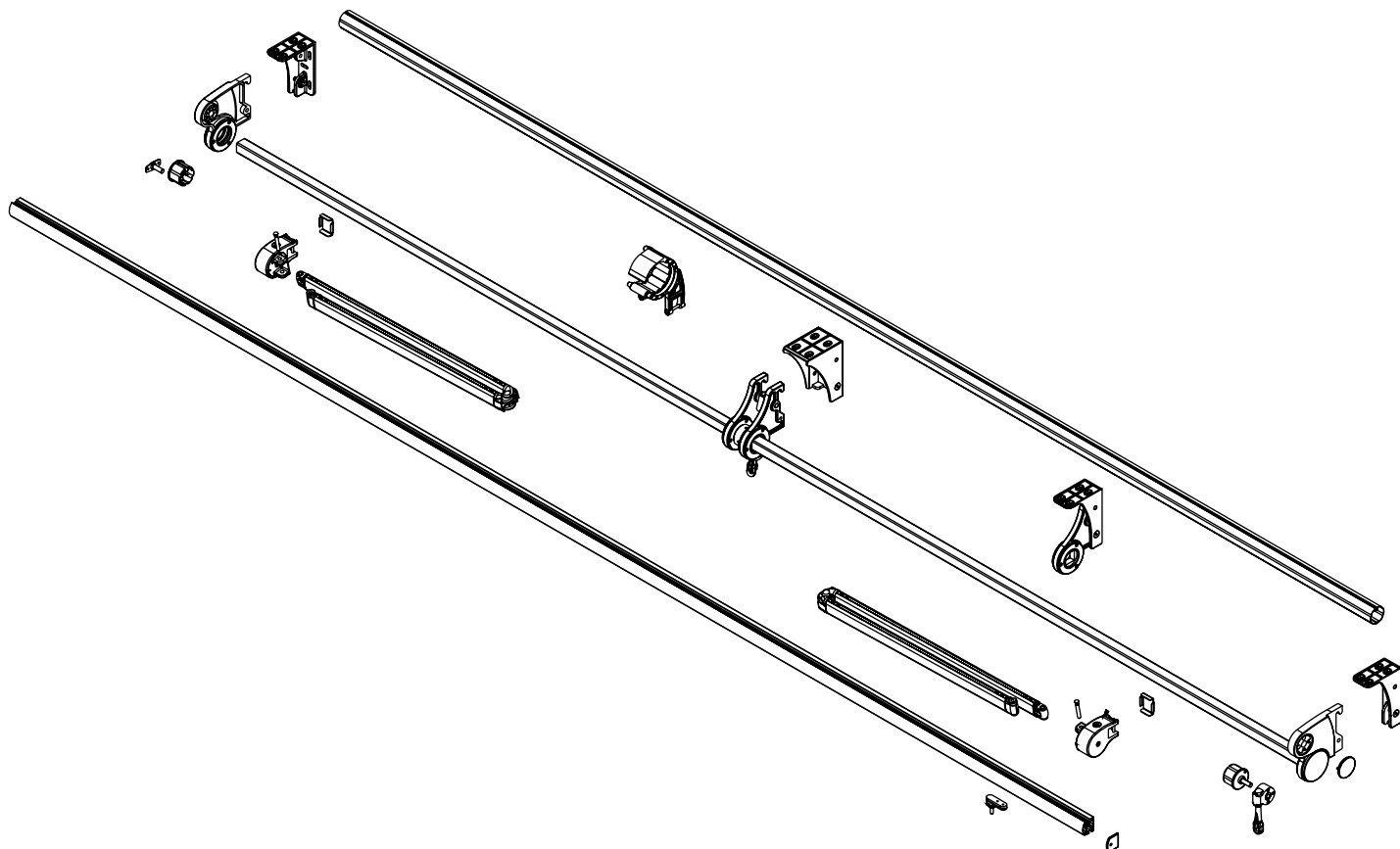

Colori di serie / Standard color / Couleurs standard



Ral
Bianco
9010

Ral
Antracite

Ral
Avorio
1013

Ral
Marrone
8017

Ral
Grigio
7035

Altri colori / Another colors / Autres couleurs +20%

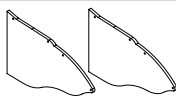
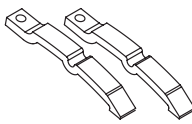
Disegno Figure Dessign	Descrizione Description Description	Informazioni Informations Information	Codice Article Code Code Article	U.M. Unit	Prezzo unitario Unit price Prix unitaire	Conf. std. Std. pack Cf. std
	Arganello 11:1 Awning gearbox 11:1 Treuil 11:1		ARG11:A	Pz		25
	Supporto braccio compact C90 Support for arm compact C90 Support bras compact c90		COMP0002/90	Cp		10
	Staffe parete soffitto Bracket wall/ceiling Supports mur/plafond		SHDW-033	Cp		5
	Supporto intermedio Intermediate support Support intermédiaire		SHDW-032	Pz		10
	Supporto di regolazione Adjustment support Aide au réglage		SHDW-031	Pz		10
	Scivolo raccoglibraccio in nylon Slide tray arms Goulotte ramasse-bras en nylon		SCIV00001A	Cp		100
	Tappi terminale 31266 con viti Caps for terminal profile with Screws Bouchons barre de charge 31266 avec vis		EUR0A025	Cp		50
	Scivolo snodato in alluminio Articulated slide lux Goulotte barre de charge		LUX0004A	Cp		25
	Tappo d.70 Con perno tondo 14x20 Plug with round pin dia 70 14x20 Embout ø 70 avec axe rond 14x20 Tappo d.78 Con perno tondo 14x20 Plug with round pin dia 78 14x20 Embout ø 78 avec axe rond 14x20	ø 70	TAPPT70	Pz		80
	Tappo perno quadro ø 70 Plug with square ø 70 Embout avec axe carré ø 70 Tappo perno quadro ø 78 Plug with square ø 78 Embout avec axe carré ø 78	13x48	TAPPQ70-13x48	Pz		80
	Tappi in nylon per tettino estruso Caps for roof extruded nylon Bouchons en nylon pour auvent extrudé		BQC0A029	Cp		20
	Stecchette per tettino Cues for roof Branchettes pour auvent		BQA0A029	Cp		10
	Staffe intermediale regolabili per tettino Intermediate bracket for roof Square bar Supports intermediaires réglables pour auvent		BQC0A039	Pz		10

Disegno Figure Dessign	Descrizione Description Description	Informazioni Informations Information	Codice Article Code Code Article	U.M. Unit Unit	Prezzo unitario Unit price Prix unitaire	Conf. std. Std. pack Cf. std
------------------------------	---	---	--	----------------------	--	------------------------------------

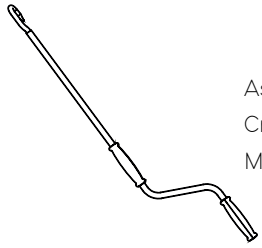

Asta di manovra verniciata
Crank handle
Manivelle

Cm 100	AST0A100
Cm 120	AST0A120
Cm 150	AST0A150
Cm 180	AST0A180
Cm 200	AST0A200
Cm 220	AST0A220
Cm 250	AST0A250
Cm 300	AST0A300

Cp

10

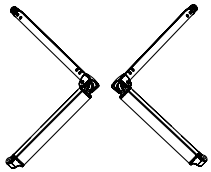

Bracci a catena
Arms with chain
Bras à chaîne

Cm 160	KIR0A160
Cm 185	KIR0A185
Cm 210	KIR0A210
Cm 235	KIR0A235
Cm 260	KIR0A260
Cm 285	KIR0A285
Cm 310	KIR0A310

Cp

10

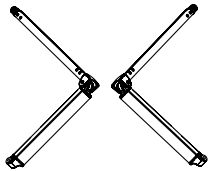

Bracci a cavetto
Arms with cable
Bras à câble

Cm 160	CAV0A160
Cm 185	CAV0A185
Cm 210	CAV0A210
Cm 235	CAV0A235
Cm 260	CAV0A260
Cm 285	CAV0A285
Cm 310	CAV0A310

Cp

10

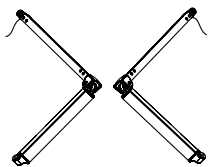

Bracci led KIRO a catena
Arms with chain
Bras à chaîne

Cm 160	KIRO-LED-160A
Cm 185	KIRO-LED-185A
Cm 210	KIRO-LED-210A
Cm 235	KIRO-LED-235A
Cm 260	KIRO-LED-260A
Cm 285	KIRO-LED-285A
Cm 310	KIRO-LED-310A

Cp

10

Disegno Figure Dessign	Descrizione Description Description	Informazioni Informations Information	Codice Article Code Code Article	U.M. Unit	Prezzo unitario Unit price Prix unitaire	Conf. std. Std. pack Cf. std
------------------------------	---	---	--	--------------	--	------------------------------------

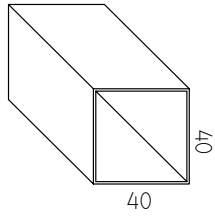

Barra quadra 40x40 in ferro Zincata e verniciata
Square bar 40x40 iron zinc
Painted
Barre carrée 40x40 en fer galvanisé et peint

Cm 400 BQC4A001
Cm 500 BQC5A001
Cm 600 BQC6A001
Cm 700 BQC7A001

Pz

10

2393gr/ml

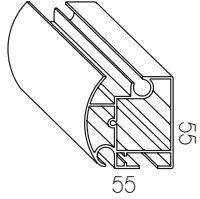

Terminale 31266
Terminal profile 31266
Barre de charge 31266

Cm 400 BQC4A030
Cm 500 BQC5A030
Cm 600 BQC6A030
Cm 700 BQC7A030

Pz

10

1276gr/ml

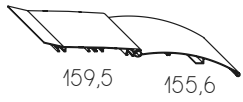

Tettino estruso
Roof extruded
Auvent extrudé

Cm 400 BQC4A1ES
Cm 500 BQC5A1ES
Cm 600 BQC6A1ES
Cm 700 BQC7A1ES

Pz

10

1835gr/ml

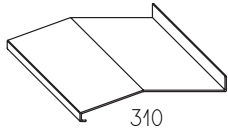

Tettino piegato
Roof allum. Bent
Auvent plié

Cm 300 BQC3A1
Cm 400 BQC4A1
Cm 500 BQC5A1
Cm 600 BQC6A1

Pz

10

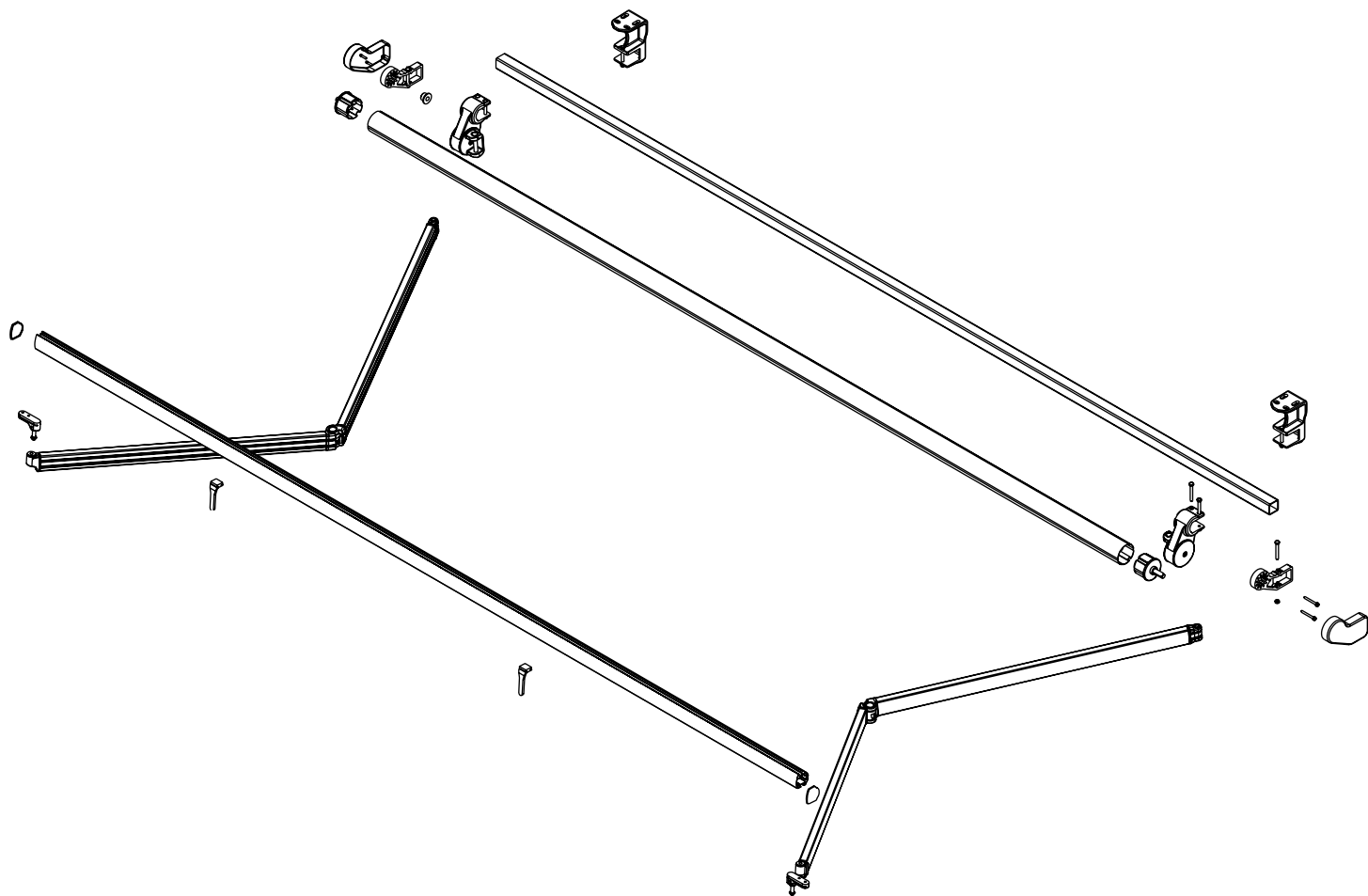

Colori di serie / Standard color / Couleurs standard





Ral
Bianco
9010







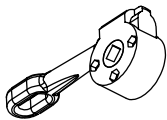
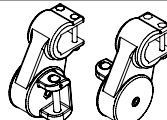
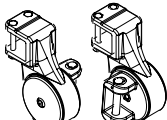
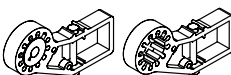
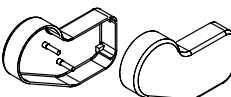
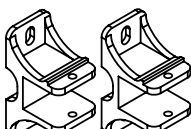
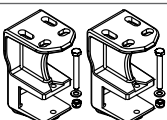
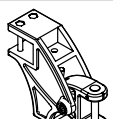
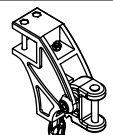
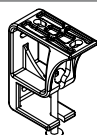
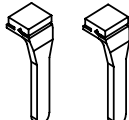

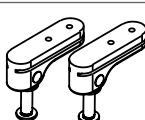
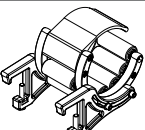
Ral
Antracite

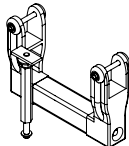
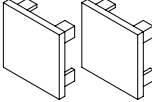
Ral
Avorio
1013

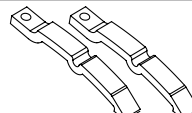
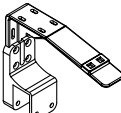
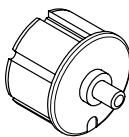
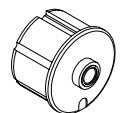
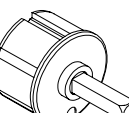
Ral
Marrone
8017

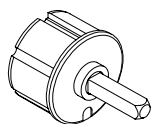
Ral
Grigio
7035

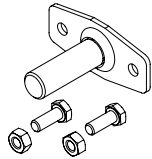
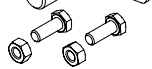
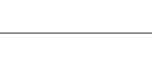
Disegno Figure Dessign	Descrizione Description Description	Informazioni Informations Information	Codice Article Code Code Article	U.M. Unit Unit price	Prezzo unitario Unit price Prix unitaire	Conf. std. Std. pack Cf. std
	Arganello 11:1 Awning gearbox 11:1 Treuil 11:1		ARG11:1A	Pz		25
	Supporto braccio kenia Support for arm kenia Support bras kenia		KENI-008A	Cp		10
	Supporto braccio elios Support for arm kenia Support bras kenia		BQCE0A001	Cp		10
	Supporto avvolgitore bqç kenia Support winder bqç kenia Support enrouleur bqç bqç kenia		BQCE-026A	Cp		10
	Cuffie per supporto avvolgitore kenia Cover for support winder kenia Bouchons pour support enrouleur kenia		KENI-006A	Cp		10
	Supporto simmetrico Support symmetrical Support symétrique		BQ40-056A	Cp		10
	Supporto universale barra quadra 40 x 40 Bracket universal square bar 40 x 40 Support universel barre carrée 40 x 40		BQC0A027	Cp		5
	Supporto braccio v 91 Support arm v 91 Support bras réglable v 91		SUPV91A	Cp		10
	Supporto braccio regolabile v 91r Support arm adjustable v 91r Support bras réglable v 91r		SUPV91REG-A	Cp		10
	Supporto universale barra quadra v10 Bracket universal square bar v10 Support universel barre carrée v10		SUPPS/V10A	Cp		20
	Scivolo raccoglibraccio in nylon Slide tray arms Goulotte ramasse-bras en nylon		SCIV00001A	Cp		100
	Tappi per terminale ELIOS Caps for square bar ELIOS Bouchons pour barre de charge ELIOS		BQCE0A006	Cp		20
	Scivolo snodato in alluminio Articulated slide lux Goulotte barre de charge		LUX0004A	Cp		25
	Supporto compensatore Balance support Support compensateur		BQC0A019	Pz		10

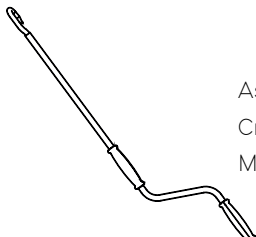
Disegno Figure Dessign	Descrizione Description Description	Informazioni Informations Information	Codice Article Code Code Article	U.M. Unit	Prezzo unitario Unit price Prix unitaire	Conf. std. Std. pack Cf. std
	Kit supporto bracci incrociati Kit support with cross arms Kit support bras croisés		BQC0A018	Pz		5
	Tappi in nylon per barra quadra Nylon caps for square bar Bouchons en nylon pour barre carrée		BQC00024A	Cp		50
	Tappi in nylon per tettino estruso Caps for roof extruded nylon Bouchons en nylon pour auvent extrudé		BQA0A029	Cp		20
	Stecchette per tettino Cues for roof Branchettes pour auvent		BQA0A029	Cp		10
	Staffe intermedie regolabili per tettino Intermediate bracket for roof Square bar Supports intermediaires réglables pour auvent		BQC0A039	Pz		10
	Tappo d.70 Con perno tondo 14x20 Plug with round pin dia 70 14x20 Embout ø 70 avec axe rond 14x20	Ø 70	TAPPT70	Pz		80
	Tappo d.78 Con perno tondo 14x20 Plug with round pin dia 78 14x20 Embout ø 78 avec axe rond 14x20	Ø 78	TAPPT78	Pz		200
	Tappo con foro Plug with hole Embout avec trou	Ø 70	TAPF70	Pz		100
	Tappo con foro Plug with hole Embout avec trou	Ø 78	TAPF78	Pz		80
	Tappo perno quadro ø 70 13 x 48 Plug with square ø 70 13 x 48 Embout avec axe carré ø 70 13 x 48	13x48	TAPPQ70-13x48	Pz		80
	Tappo perno quadro ø 78 13 x 48 Plug with square ø 78 13 x 48 Embout avec axe carré ø 78 13 x 48	13x48	TAPPQ78-13x48	Pz		100
PIASTRINA CON PERNO-PLATE WITH PIN-PLAQUETTE AVEC AXE						
	Senza bulloni e dadi Without bolts and nuts Sans boulons et écrous	13x40	PCP00001			
	Con bulloni e dadi With bolts and nuts Avec Boulons et écrous	13x75	PCP00002	Pz		100
	Senza bulloni e dadi Without bolts and nuts Sans boulons et écrous	13x40	PCP00003			
	Con bulloni e dadi With bolts and nuts Avec Boulons et écrous	13x75	PCP00004			
	Asta di manovra verniciata Crank handle Manivelle	Cm 100	AST0A100			
		Cm 120	AST0A120			
		Cm 150	AST0A150			
		Cm 180	AST0A180	Pz		10
		Cm 200	AST0A200			
		Cm 220	AST0A220			
		Cm 250	AST0A250			
		Cm 300	AST0A300			

Disegno Figure Design	Descrizione Description Description	Informazioni Informations Information	Codice Article Code Code Article	U.M. Unit	Prezzo unitario Unit price Prix unitaire	Conf. std. Std. pack Cf. std
-----------------------------	---	---	--	--------------	--	------------------------------------

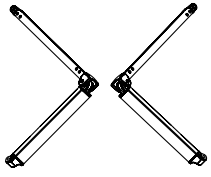

Bracci a catena
Arms with chain
Bras à chaîne

Cm 160	KIR0A160			
Cm 185	KIR0A185			
Cm 210	KIR0A210			
Cm 235	KIR0A235	Cp		10
Cm 260	KIR0A260			
Cm 285	KIR0A285			
Cm 310	KIR0A310			

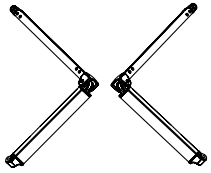

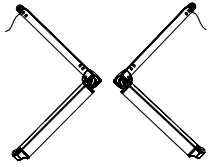

Bracci a cavetto
Arms with cable
Bras à câble

Cm 160	CAV0A160			
Cm 185	CAV0A185			
Cm 210	CAV0A210			
Cm 235	CAV0A235	Cp		10
Cm 260	CAV0A260			
Cm 285	CAV0A285			
Cm 310	CAV0A310			

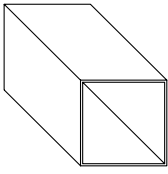
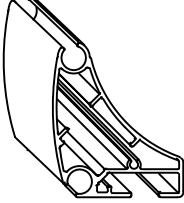
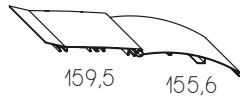
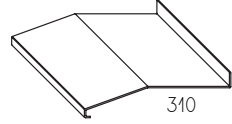
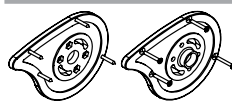

Bracci led KIRO a catena
Arms with chain
Bras à chaîne

Cm 160	KIRO-LED-160A			
Cm 185	KIRO-LED-185A			
Cm 210	KIRO-LED-210A			
Cm 235	KIRO-LED-235A	Cp		10
Cm 260	KIRO-LED-260A			
Cm 285	KIRO-LED-285A			
Cm 310	KIRO-LED-310A			

Disegno Figure Dessign	Descrizione Description Description	Informazioni Informations Information	Codice Article Code Code Article	U.M. Unit	Prezzo unitario Unit price Prix unitaire	Conf. std. Std. pack Cf. std
	Barra quadra 40x40x2 in ferro Zincata e verniciata	Cm 400	BQC4A001	Pz		10
	Square bar 40x40x2 iron zinc Painted	Cm 500	BQC5A001			
	Barre carrée 40x40x2 en fer galvanisé et peint	Cm 600	BQC6A001			
		Cm 700	BQC7A001			
		2393gr/ml				
	Terminale ELIOS	Cm 400	ELIOSTER4A	Pz		10
	Terminal profile ELIOS	Cm 500	ELIOSTER5A			
	Barre de charge ELIOS	Cm 600	ELIOSTER6A			
		Cm 700	ELIOSTER7A			
		1044gr/ml				
	Tettino estruso	Cm 400	BQC4A1ES	Pz		10
	Roof extruded	Cm 500	BQC5A1ES			
	Auvent extrudé	Cm 600	BQC6A1ES			
		Cm 700	BQC7A1ES			
		1835gr/ml				
	Tettino piegato	Cm 300	BQC3A1	Pz		10
	Roof allum. Bent	Cm 400	BQC4A1			
	Auvent plié	Cm 500	BQC5A1			
		Cm 600	BQC6A1			
<p>ATTENZIONE LA BQC COMPACT CASSONATA E' REALIZZATA CON GLI STESSI ACCESSORI DELLA KENIA</p> <p>ATTENTION BQC THE BOX COMPACT AND MADE WITH THE SAME ACCESSORIES KENIA</p> <p>ATTENTION LE BQC COMPACT AVEC COFFRE EST FAIT AVEC LES MÊMES ACCESSOIRES DU KENIA</p>						
	Tappi cassonetto Cap for box Bouchon coffre		BQCE0A004	Cp		10
	Supporto cassonetto Support for box Support coffre		BQCE0A005	Pz		10
	Supporto cassonetto Support for box Support coffre	Cm 400	ELIOSCASS4A	Pz		10
		Cm 500	ELIOSCASS5A			
		Cm 600	ELIOSCASS6A			
		Cm 700	ELIOSCASS7A			
		1970gr/ml				

Note

A large rectangular area with horizontal dotted lines, intended for writing notes.

BQ 40 PLUS

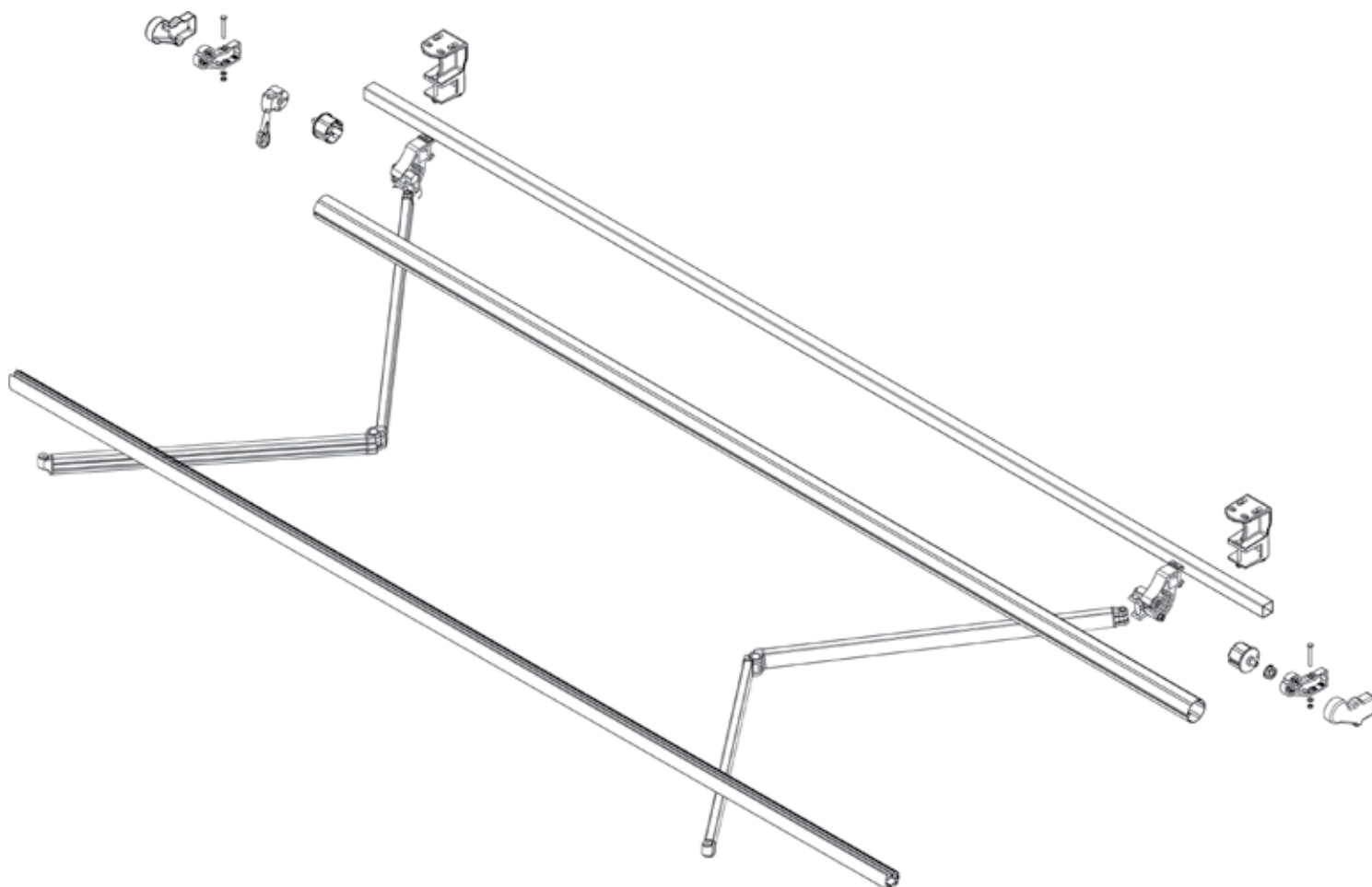

Colori di serie / Standard color / Couleurs standard





Ral
Bianco
9010

Ral
Avorio
1013

Ral
Grigio
7035

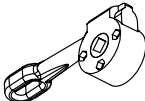
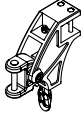
Altri colori / Another colors / Autres couleurs +20%

Disegno Figure Dessign	Descrizione Description Description	Informazioni Informations Information	Codice Article Code Code Article	U.M. Unit Unit	Prezzo unitario Unit price Prix unitaire	Conf. std. Std. pack Cf. std
	Arganello 11:1 Awning gearbox 11:1 Treuil 11:1		ARGM11A	Pz		25
	Supporto braccio bq 40 plus support for arm bq 40 plus Support bras bq 40 plus		BQ40A001	Cp		25
	Supporto avvolgitore bqç elios Support winder bqç elios Support enrouleur bqç bqç elios		BQCE-026A	Cp		10
	Cuffie per supporto avvolgitore bq 40 plus Cover for support winder bq 40 plus Bouchons pour support enrouleur bq 40 plus		BQC0A017	Cp		10
	Supporto simmetrico Support symmetrical Support symétrique		BQ40-056A	Cp		10
	Supporto universale barra quadra 40 x 40 Bracket universal square bar 40 x 40 Support universel barre carrée 40 x 40		BQC0A027	Cp		5
	Supporto braccio v 91 Support arm v 91 Support bras réglable v 91		SUPV91A	Cp		10
	Supporto braccio regolabile v 91r Support arm adjustable v 91r Support bras réglable v 91r		SUPV91REG-A	Cp		10
	Supporto universale barra quadra v10 Bracket universal square bar v10 Support universel barre carrée v10		SUPPS/V10A	Cp		20
	Scivolo raccoglibraccio in nylon Slide tray arms Goulotte ramasse-bras en nylon		SCIV00001A	Cp		100
	Tappi per terminale 30600 con viti Caps for square bar 30600 with Screws Bouchons pour barre de charge 30600 avec vis		KIR0A025	Cp		50
	Scivolo snodato in alluminio Articulated slide lux Goulotte barre de charge		LUX0004A	Cp		25
	Tappo d.70 Con perno tondo 14x20 Plug with round pin dia 70 14x20 Embout ø 70 avec axe rond 14x20	Ø 70	TAPPT70	Pz		80
	Tappo con foro Plug with hole Embout avec trou	Ø 70	TAPF70	Pz		200
	Tappo perno quadro ø 70 Plug with square ø 70 Embout avec axe carré ø 70	13x48	TAPPQ70-13x48	Pz		80

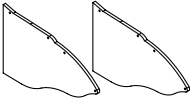
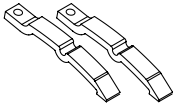
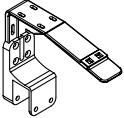
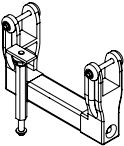
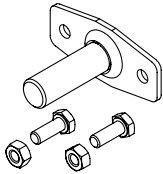
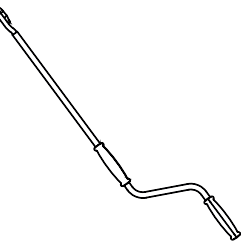
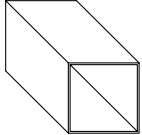
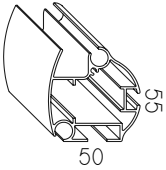
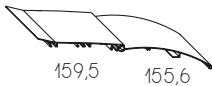
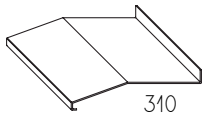
Disegno Figure Dessign	Descrizione Description Description	Informazioni Informations Information	Codice Article Code Code Article	U.M. Unit Unit	Prezzo unitario Unit price Prix unitaire	Conf. std. Std. pack Cf. std
	Tappi in nylon per tettino estruso Caps for roof extruded nylon Bouchons en nylon pour auvent extrudé		BQA0A029	Cp		20
	Stecchette per tettino Cues for roof Branchettes pour auvent		BQA0A029	Cp		10
	Staffe intermedie regolabili per tettino Intermediate bracket for roof Square bar Supports intermediaires réglables pour auvent		BQC0A039	Pz		10
	Kit supporto bracci incrociati Kit support with cross arms Kit support bras croisés		BQC0A018	Pz		5
	PIASTRINA CON PERNO-PLATE WITH PIN-PLAQUETTE AVEC AXE Senza bulloni e dadi Without bolts and nuts Sans boulons et écrous Con bulloni e dadi With bolts and nuts Avec Boulons et écrous	13x40 13x75 13x40 13x75	PCP00001 PCP00002 PCP00003 PCP00004	Pz		100
	Asta di manovra verniciata Crank handle Manivelle	Cm 100 Cm 120 Cm 150 Cm 180 Cm 200 Cm 220 Cm 250 Cm 300	AST0A100 AST0A120 AST0A150 AST0A180 AST0A200 AST0A220 AST0A250 AST0A300	Pz		10
	Barra quadra 40x40 in ferro Zincata e verniciata Square bar 40x40 iron zinc Painted Barre carrée 40x40 en fer galvanisé et peint	Cm 400 Cm 500 Cm 600 Cm 700	BQC4A001 BQC5A001 BQC6A001 BQC7A001	Pz		10
	Terminale 30600 Terminal profile 30600 Barre de charge 30600		Cm 400 Cm 500 Cm 600 Cm 700	KIR4A001 KIR5A001 KIR6A001 KIR7A001	Pz	10
	Tettino estruso Roof extruded Auvent extrudé		Cm 400 Cm 500 Cm 600 Cm 700	BQC4A1ES BQC5A1ES BQC6A1ES BQC7A1ES	Pz	10
	Tettino piegato Roof allum. Bent Auvent plié		Cm 300 Cm 400 Cm 500 Cm 600	BQC3A1 BQC4A1 BQC5A1 BQC6A1	Pz	10

Disegno Figure Design	Descrizione Description Description	Informazioni Informations Information	Codice Article Code Code Article	U.M. Unit	Prezzo unitario Unit price Prix unitaire	Conf. std. Std. pack Cf. std
-----------------------------	---	---	--	--------------	--	------------------------------------

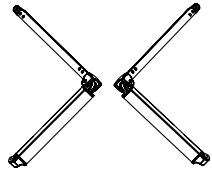

Bracci a catena
Arms with chain
Bras à chaîne

Cm 160	KIR0A160			
Cm 185	KIR0A185			
Cm 210	KIR0A210			
Cm 235	KIR0A235	Cp		10
Cm 260	KIR0A260			
Cm 285	KIR0A285			
Cm 310	KIR0A310			

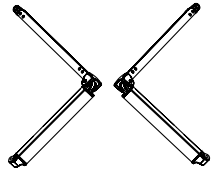

Bracci a cavetto
Arms with cable
Bras à câble

Cm 160	CAV0A160			
Cm 185	CAV0A185			
Cm 210	CAV0A210			
Cm 235	CAV0A235	Cp		10
Cm 260	CAV0A260			
Cm 285	CAV0A285			
Cm 310	CAV0A310			

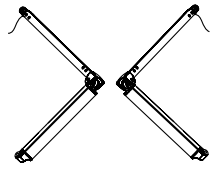

Bracci led KIRO a catena
Arms with chain
Bras à chaîne

Cm 160	KIRO-LED-160A			
Cm 185	KIRO-LED-185A			
Cm 210	KIRO-LED-210A			
Cm 235	KIRO-LED-235A	Cp		10
Cm 260	KIRO-LED-260A			
Cm 285	KIRO-LED-285A			
Cm 310	KIRO-LED-310A			

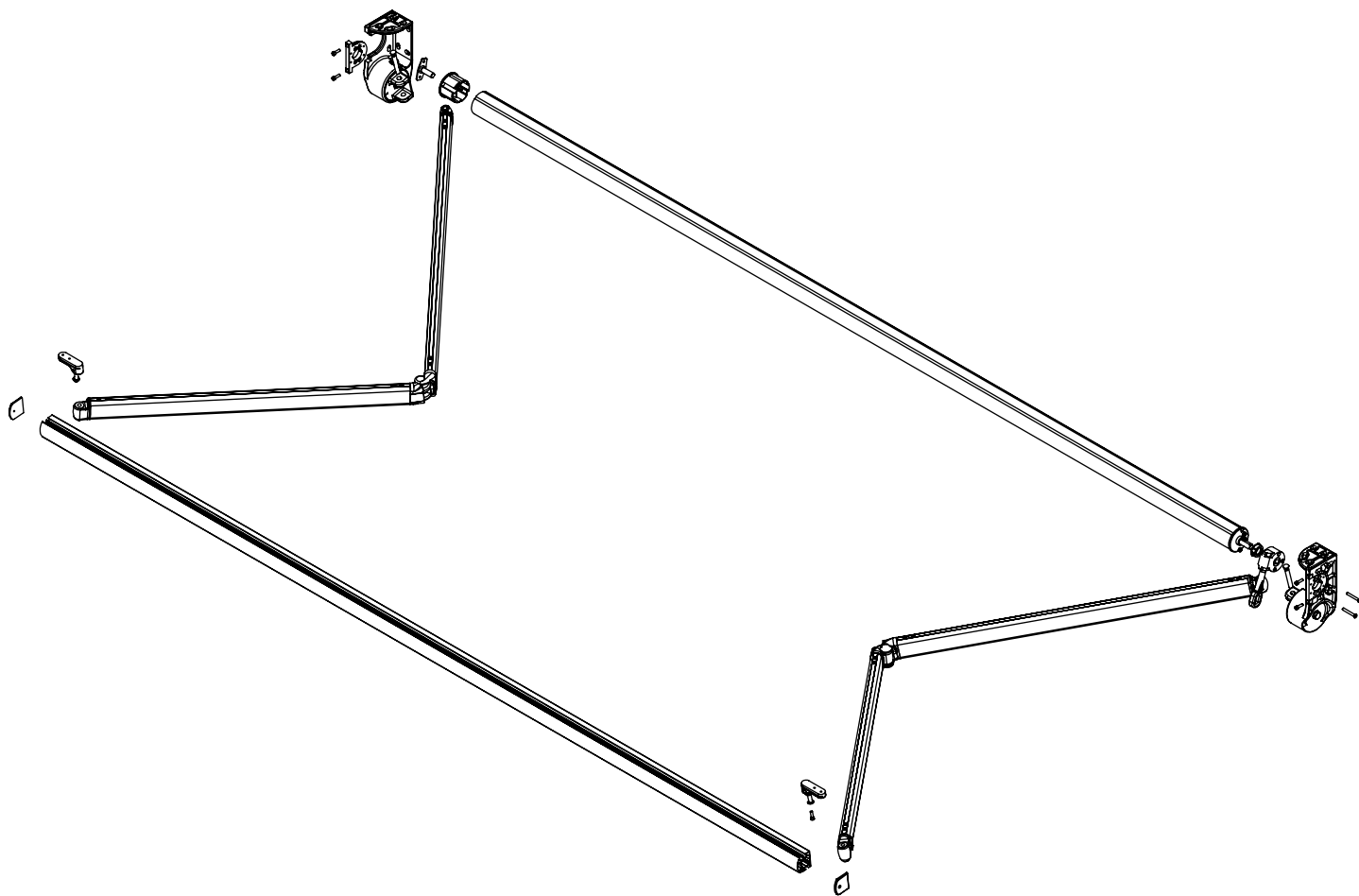

Colori di serie / Standard color / Couleurs standard



Ral Bianco 9010	Ral Avorio 1013	Ral Grigio 7035	Ral Marrone 8017	Ral Antracite
-----------------------	-----------------------	-----------------------	------------------------	------------------

Altri colori / Another colors / Autres couleurs +20%

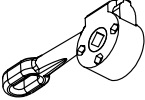
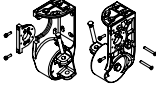
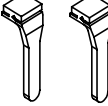
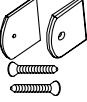
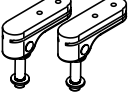
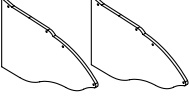
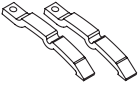
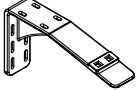
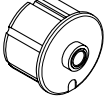
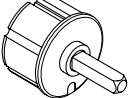
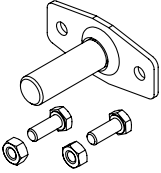
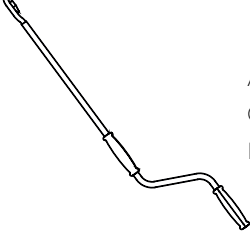
Disegno Figure Dessign	Descrizione Description Description	Informazioni Informations Information	Codice Article Code Code Article	U.M. Unit	Prezzo unitario Unit price Prix unitaire	Conf. std. Std. pack Cf. std
	Arganello 11:1 Awning gearbox 11:1 Treuil 11:1		ARGM11A	Pz		25
	Supporto parete soffitto spagna Support wall/ceiling Support mur/plafond spagna		BQCS-007A	Cp		10
	Scivolo raccoglibraccio in nylon Slide tray arms Goulotte ramasse-bras en nylon		SCIV00001A	Cp		100
	Tappi terminale 31266 con viti Caps for square bar 31226 with Screws Bouchons pour barre de charge 31226 avec vis		EUR0A025	Cp		50
	Scivolo snodato in alluminio Articulated slide lux Goulotte barre de charge		LUX0004A	Cp		25
	Tappi in nylon per tettino estruso Caps for roof extruded nylon Bouchons en nylon pour auvent extrudé		BQC0A029	Cp		20
	Stecchette per tettino Cues for roof Branchettes pour auvent		BQA0A029	Cp		10
	Staffe intermedie regolabili per tettino Intermediate bracket for roof Square bar Supports intermediaires réglables pour auvent		BQ40-017A	Pz		10
	Tappo con foro Plug with hole Embout avec trou	Ø 70	TAPF70	Pz		200
	Tappo perno quadro Ø 70 Plug with square Ø 70 Embout avec axe carré Ø 70	13x40	TAPPQ70-13X40	Cp		80
	PIASTRINA CON PERNO-PLATE WITH PIN-PLAQUETTE AVEC AXE Senza bulloni e dadi Without bolts and nuts Sans boulons et écrous Con bulloni e dadi With bolts and nuts Avec Boulons et écrous	13x40 13x75 13x40 13x75	PCP00001 PCP00002 PCP00003 PCP00004	Pz		100
	Asta di manovra verniciata Crank handle Manivelle	Cm 100 Cm 120 Cm 150 Cm 180 Cm 200 Cm 220 Cm 250 Cm 300	AST0A100 AST0A120 AST0A150 AST0A180 AST0A200 AST0A220 AST0A250 AST0A300	Pz		10

Disegno Figure Dessign	Descrizione Description Description	Informazioni Informations Information	Codice Article Code Code Article	U.M. Unit	Prezzo unitario Unit price Prix unitaire	Conf. std. Std. pack Cf. std
	Bracci a catena Arms with chain Bras à chaîne	Cm 160	BRA0A160	Cp		10
		Cm 185	BRA0A185			
		Cm 210	BRA0A210			
		Cm 235	BRA0A235			
		Cm 260	BRA0A260			
		Cm 285	BRA0A285			
	Bracci a cavetto Arms with cable Bras à câble	Cm 160	BQCCAV0A160	Cp		10
		Cm 185	BRACAV0A185			
		Cm 210	BRACAV0A210			
		Cm 235	BRACAV0A235			
		Cm 260	BRACAV0A260			
		Cm 285	BRACAV0A285			
	Bracci a catena twister Arms with chain twister Bras à chaîne twister	Cm 160	TWS0A160	Cp		10
		Cm 185	TWS0A185			
		Cm 210	TWS0A210			
		Cm 235	TWS0A235			
		Cm 260	TWS0A260			
		Cm 285	TWS0A285			
	Bracci led a catena Arms with chain Bras à chaîne	Cm 160	BQC-LED-160A	Cp		10
		Cm 185	BQC-LED-185A			
		Cm 210	BQC-LED-210A			
		Cm 235	BQC-LED-235A			
		Cm 260	BQC-LED-260A			
		Cm 285	BQC-LED-285A			
	Terminale 31266 Terminal profile 31266 Barre de charge 31266	Cm 400	BQC4A030	Pz		10
		Cm 500	BQC5A030			
		Cm 600	BQC6A030			
		Cm 700	BQC6A030			
		1276gr/ml				
	Tettino estruso Roof extruded Auvent extrudé	Cm 400	BQC4A1ES	Pz		10
		Cm 500	BQC5A1ES			
		Cm 600	BQC6A1ES			
		Cm 700	BQC7A1ES			
		1835gr/ml				
	Tettino piegato Roof allum. Bent Auvent plié	Cm 300	BQC3A1	Pz		10
		Cm 400	BQC4A1			
		Cm 500	BQC5A1			
		Cm 600	BQC6A1			

Note

A large rectangular area with horizontal dotted lines, intended for writing notes.

OMBRA

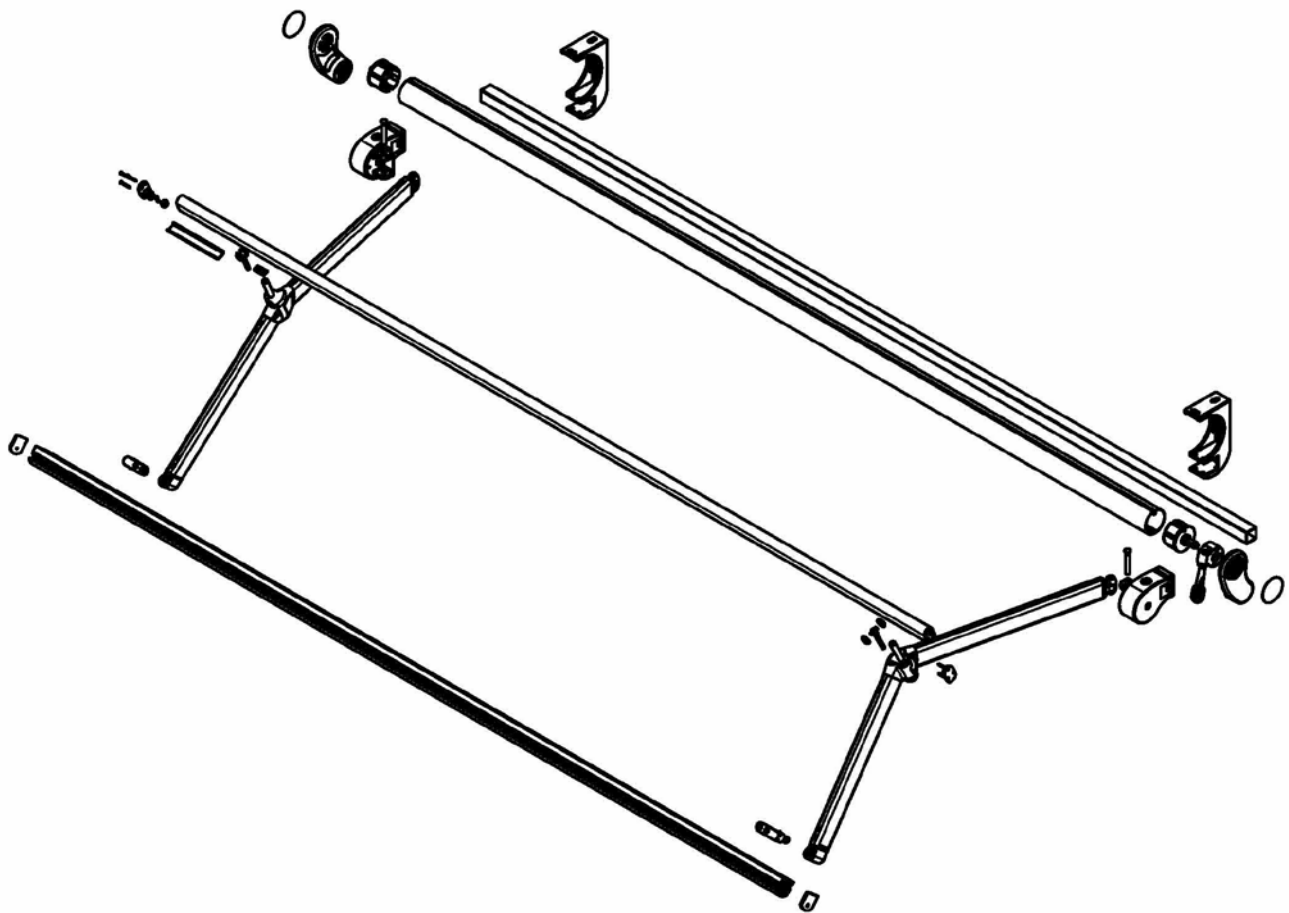

Colori di serie / Standard color / Couleurs standard



Ral	Ral	Ral	Ral
Bianco	Avorio	Grigio	Marrone
9010	1013	7035	8017

Altri colori / Another colors / Autres couleurs +20%

Disegno Figure Design	Descrizione Description Description	Informazioni Informations Information	Codice Article Code Code Article	U.M. Unit Unit	Prezzo unitario Unit price Prix unitaire	Conf. std. Std. pack Cf. std
	Arganello 11:1 Awning gearbox 11:1 Treuil 11:1		ARGM11A	Pz		25
	Supporto braccio compact C90 Support for arm compact C90 Support bras compact c90		COMP0002/90	Cp		10
	Supporto avvolgitore lux/compact Support winder b4c lux/compact Support enrouleur b4c lux/compact		LUX0002A	Cp		10
	Staffe parete soffitto b4c compact Bracket wall/ceiling compact Supports mur/plafond b4c compact		COMP0001	Cp		5
	Supporto braccio v 91 Support arm v 91 Support bras réglable v 91		SUPV91A	Cp		10
	Supporto braccio regolabile v 91r Support arm adjustable v 91r Support bras réglable v 91r		SUPV91REG-A	Cp		10
	Scivolo raccoglibraccio in nylon Slide tray arms Goulotte ramasse-bras en nylon		SCIV00001A	Cp		100
	Tappi terminale 31266 con viti Caps for terminal profile with Screws Bouchons barre de charge 31266 avec vis		EURO0A025	Cp		50
	Scivolo snodato in alluminio Articulated slide lux Goulotte barre de charge		LUX0004A	Cp		25
	Supporto compensatore Balance support for b4c compact Support compensateur		COMP0004A	Pz		10
	Tappo d.70 Con perno tondo 14x20 Plug with round pin dia 70 14x20 Embout ø 70 avec axe rond 14x20		TAPPT70	Pz		80
	Tappo perno quadro ø 70 Plug with square ø 70 Embout avec axe carré ø 70	13x48	TAPPQ70-13X48	Cp		80
	Corda ombra Cord ombra Corde ombra		CORD-OMBRA	MI		200

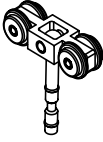
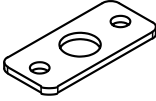
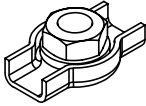
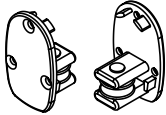
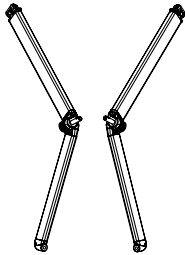
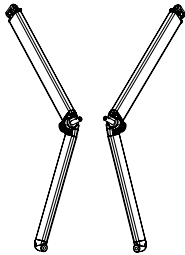
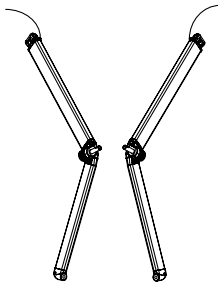
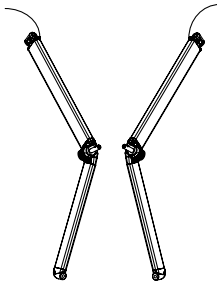
Disegno Figure Dessign	Descrizione Description Description	Informazioni Informations Information	Codice Article Code Code Article	U.M. Unit Unit	Prezzo unitario Unit price Prix unitaire	Conf. std. Std. pack Cf. std
	Carrello frangivento ombra Shadow windbreak ombra Chariot brise-vent ombra		OMBR-017A	Pz		10
	Piastrina per carrello frangivento Ombra Plate for trolley for windbreak Profil ombra Plaque pour chariot brise-vent ombra		OMBR-014	Pz		10
	Morsetto simplex Morsetto simplex Étau simplex		OMBR-011	Pz		10
	Tappo frangivento ombra Caps for windbreak ombra Bouchon brise-vent ombra		OMBR-018A	Cp		10
	Bracci Ombra 130° A Cavetto Arms Ombra 130° With Cable Bras Ombra 130° À Câble	Cm 135	OMBR0A135-130	Cp		10
		Cm 160	OMBR0A160-130			
		Cm 185	OMBR0A185-130			
		Cm 210	OMBR0A210-130			
		Cm 235	OMBR0A235-130			
		Cm 260	OMBR0A260-130			
		Cm 285	OMBR0A285-130			
Cm 310	OMBR0A310-130					
	Bracci ombra 170° a cavetto Arms ombra 170° with cable Bras ombra 170° à câble	Cm 135	OMBR0A135-170	Cp		10
		Cm 160	OMBR0A160-170			
		Cm 185	OMBR0A185-170			
		Cm 210	OMBR0A210-170			
		Cm 235	OMBR0A235-170			
		Cm 260	OMBR0A260-170			
		Cm 285	OMBR0A285-170			
Cm 310	OMBR0A310-170					
	Bracci Ombra 130° Led A Cavetto Arms Ombra 130° Led With Cable Bras Ombra 130° Led À Câble	Cm 135	OMBR0A135-130L	Cp		10
		Cm 160	OMBR0A160-130L			
		Cm 185	OMBR0A185-130L			
		Cm 210	OMBR0A210-130L			
		Cm 235	OMBR0A235-130L			
		Cm 260	OMBR0A260-130L			
		Cm 285	OMBR0A285-130L			
Cm 310	OMBR0A310-130L					
	Bracci ombra 170° Led a cavetto Arms ombra 170° Led with cable Bras ombra 170° Led à câble	Cm 135	OMBR0A135-170L	Cp		10
		Cm 160	OMBR0A160-170L			
		Cm 185	OMBR0A185-170L			
		Cm 210	OMBR0A210-170L			
		Cm 235	OMBR0A235-170L			
		Cm 260	OMBR0A260-170L			
		Cm 285	OMBR0A285-170L			
Cm 310	OMBR0A310-170L					

Disegno Figure Design	Descrizione Description Description	Informazioni Informations Information	Codice Article Code Code Article	U.M. Unit Unit price	Prezzo unitario Unit price Prix unitaire	Conf. std. Std. pack Cf. std
	Terminale 31266	Cm 400	BQC4A030	Pz		10
	Terminal profile 31266	Cm 500	BQC5A030			
	Barre de charge 31266	Cm 600	BQC6A030			
		Cm 700	BQC6A030			
		1276gr/ml				
	Tettino piegato	Cm 300	BQC3A1	Pz		10
	Roof allum. Bent	Cm 400	BQC4A1			
	Auvent plié	Cm 500	BQC5A1			
		Cm 600	BQC6A1			
	Barra quadra 40x40 in ferro Zincata e verniciata	Cm 400	BQC4A001	Pz		10
	Square bar 40x40 iron zinc Painted	Cm 500	BQC5A001			
	Barre carrée 40x40 en fer galvanisé et peint	Cm 600	BQC6A001			
		Cm 700	BQC7A001			
		2393gr/ml				
	Frangivento ombra	Cm 400	FGOMBRA4	Pz		10
	Windbreak ombra	Cm 500	FGOMBRA5			
	Brise-vent ombra	Cm 600	FGOMBRA6			
		Cm 700	FGOMBRA7			
		946gr/ml				
	Coprifilo frangivento ombra	Cm 500	CFOMBRA5	Pz		10
	Cover rope for windbreak Ombra	282gr/ml				
	Couvre-fil brise-vent ombra					

KIRO 40 BQ

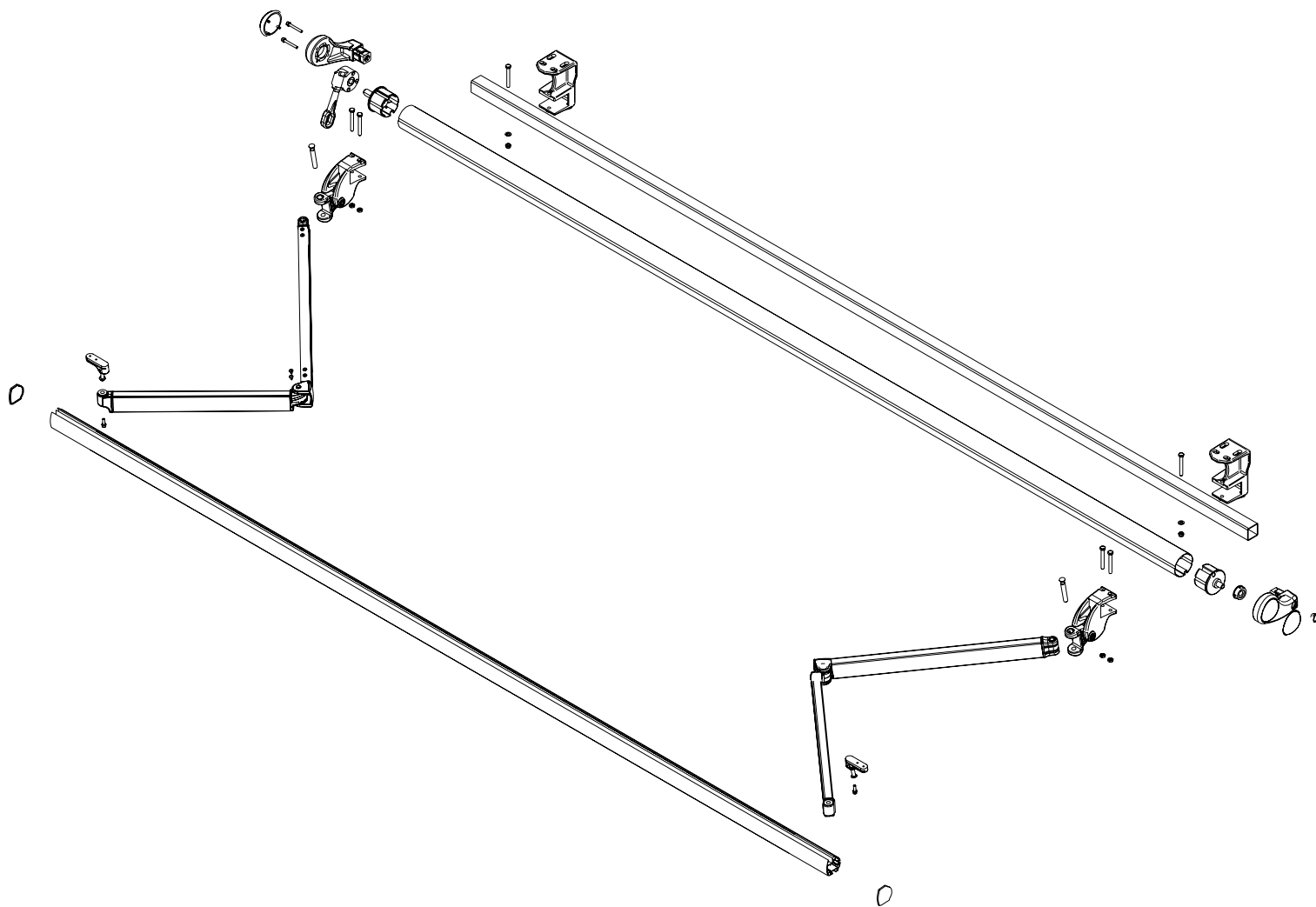
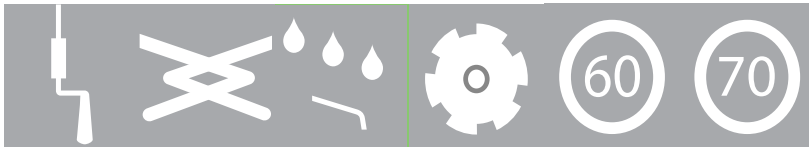

Colori di serie / Standard color / Couleurs standard



Ral
Bianco
9010

Ral
Antracite

Ral
Avorio
1013

Ral
Marrone
8017

Ral
Grigio
7035

Altri colori / Another colors / Autres couleurs +20%

Disegno Figure Dessign	Descrizione Description Description	Informazioni Informations Information	Codice Article Code Code Article	U.M. Unit Unit	Prezzo unitario Unit price Prix unitaire	Conf. std. Std. pack Cf. std
	Arganello 11:1 Awning gearbox 11:1 Treuil 11:1		ARG11A	Pz		25
	Supporto braccio kiro 40 Support for arm kiro 40 Support bras kiro 40		KIR0A024	Cp		10
	Supporto avvolgitore kiro 40 Support winder kiro 40 Support enrouleur kiro 40		KIR0A023	Cp		10
	Supporto universale barra quadra 40 x 40 Bracket universal square bar 40 x 40 Support universel barre carrée 40 x 40		BQC0A027	Cp		5
	Supporto simmetrico Support symmetrical Support symétrique		BQ40-056A	Cp		10
	Staffa sottotetto Roof bracket on square bar Support sous-toit		BQ40-015A	Cp		10
	Supporto braccio v 91 Support arm v 91 Support bras réglable v 91		SUPV91A	Cp		100
	Supporto braccio regolabile v 91r Support arm adjustable v 91r Support bras réglable v 91r		SUPV91REG-A	Cp		50
	Supporto universale barra quadra v10 Bracket universal square bar v10 Support universel barre carrée v10		SUPPS/V10A	Cp		25
	Scivolo raccoglibraccio in nylon Slide tray arms Goulotte ramasse-bras en nylon		SCIV00001A	Cp		10
	Tappi per terminale 30600 con viti Caps for square bar 30600 with Screws Bouchons pour barre de charge 3060 avec vis		KIR0A025	Cp		20
	Scivolo snodato in alluminio Articulated slide lux Goulotte barre de charge		LUX0004A	Cp		10
	Tappi in nylon per barra quadra Nylon caps for square bar Bouchons en nylon pour barre carrée		BQC00024A	Cp		50
	Tappo d.70 Con perno tondo 14x20 Plug with round pin dia 70 14x20 Embout ø 70 avec axe rond 14x20		TAPPT70	Pz		80
	Tappo perno quadro ø 70 Plug with square ø 70 Embout avec axe carré ø 70	13x48	TAPPQ70-13x48	Cp		80
	Kit supporto bracci incrociati Kit support with cross arms Kit support bras croisés		BQC0A018	Pz		5

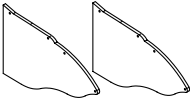
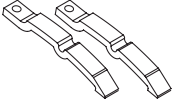
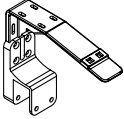
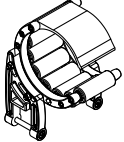
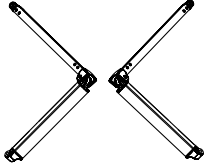
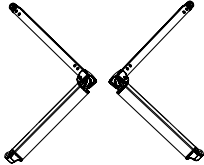
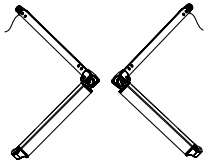
Disegno Figure Dessign	Descrizione Description Description	Informazioni Informations Information	Codice Article Code Code Article	U.M. Unit	Prezzo unitario Unit price Prix unitaire	Conf. std. Std. pack Cf. std
	Tappi in nylon per tettino estruso Caps for roof extruded nylon Bouchons en nylon pour auvent extrudé		BQC0A029	Cp	8,79	20
	Stecchette per tettino Cues for roof Branchettes pour auvent		BQA0A029	Cp		10
	Staffe intermediale regolabili per tettino Intermediate bracket for roof Square bar Supports intermediaires réglables pour auvent		BQC0A039	Pz		10
	Supporto compensatore Balance support Support compensateur		BQC0A019	Pz		10
	Bracci a catena Arms with chain Bras à chaîne	Cm 160	KIR0A160	Cp		10
		Cm 185	KIR0A185			
		Cm 210	KIR0A210			
		Cm 235	KIR0A235			
		Cm 260	KIR0A260			
		Cm 285	KIR0A285			
Cm 310	KIR0A310					
	Bracci a cavetto Arms with cable Bras à câble	Cm 160	CAV0A160	Cp		10
		Cm 185	CAV0A185			
		Cm 210	CAV0A210			
		Cm 235	CAV0A235			
		Cm 260	CAV0A260			
		Cm 285	CAV0A285			
Cm 310	CAV0A310					
	Bracci led KIRO a catena Arms with chain Bras à chaîne	Cm 160	KIRO-LED-160A	Cp		10
		Cm 185	KIRO-LED-185A			
		Cm 210	KIRO-LED-210A			
		Cm 235	KIRO-LED-235A			
		Cm 260	KIRO-LED-260A			
		Cm 285	KIRO-LED-285A			
Cm 310	KIRO-LED-310A					

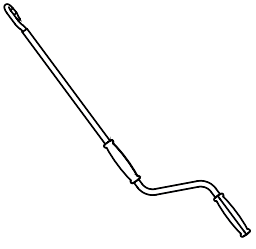
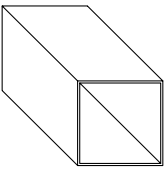
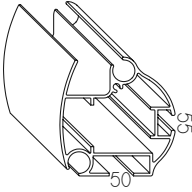
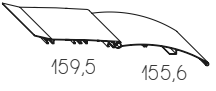
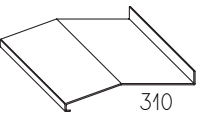
Disegno Figure Dessign	Descrizione Description Description	Informazioni Informations Information	Codice Article Code Code Article	U.M. Unit Unit price	Prezzo unitario Unit price Prix unitaire	Conf. std. Std. pack Cf. std
	Asta di manovra verniciata Crank handle Manivelle	Cm 100	AST0A100	Pz		10
		Cm 120	AST0A120			
		Cm 150	AST0A150			
		Cm 180	AST0A180			
		Cm 200	AST0A200			
		Cm 220	AST0A220			
		Cm 250	AST0A250			
		Cm 300	AST0A300			
	Barra quadra 40x40 in ferro Zincata e verniciata Square bar 40x40 iron zinc Painted Barre carrée 40x40 en fer galvanisé et peint	Cm 400	BQC4A001	Pz		10
		Cm 500	BQC5A001			
		Cm 600	BQC6A001			
		Cm 700	BQC7A001			
	Terminale 30600 Terminal profile 30600 Barre de charge 30600	Cm 400	KIR4A001	Pz		10
		Cm 500	KIR5A001			
		Cm 600	KIR6A001			
		Cm 700	KIR7A001			
	Tettino estruso Roof extruded Auvent extrudé	Cm 400	BQC4A1ES	Pz		10
		Cm 500	BQC5A1ES			
		Cm 600	BQC6A1ES			
		Cm 700	BQC7A1ES			
	Tettino piegato Roof allum. Bent Auvent plié	Cm 300	BQC3A1	Pz		10
		Cm 400	BQC4A1			
		Cm 500	BQC5A1			
		Cm 600	BQC6A1			

LIBERTY P/S ECLISSE



LIBERTY

Colori di serie / Standard color / Couleurs standard



Ral Bianco 9010	Ral Antracite	Ral Avorio 1013	Ral Marrone 8017	Ral Grigio 7035
-----------------------	------------------	-----------------------	------------------------	-----------------------

Altri colori / Another colors / Autres couleurs +20%

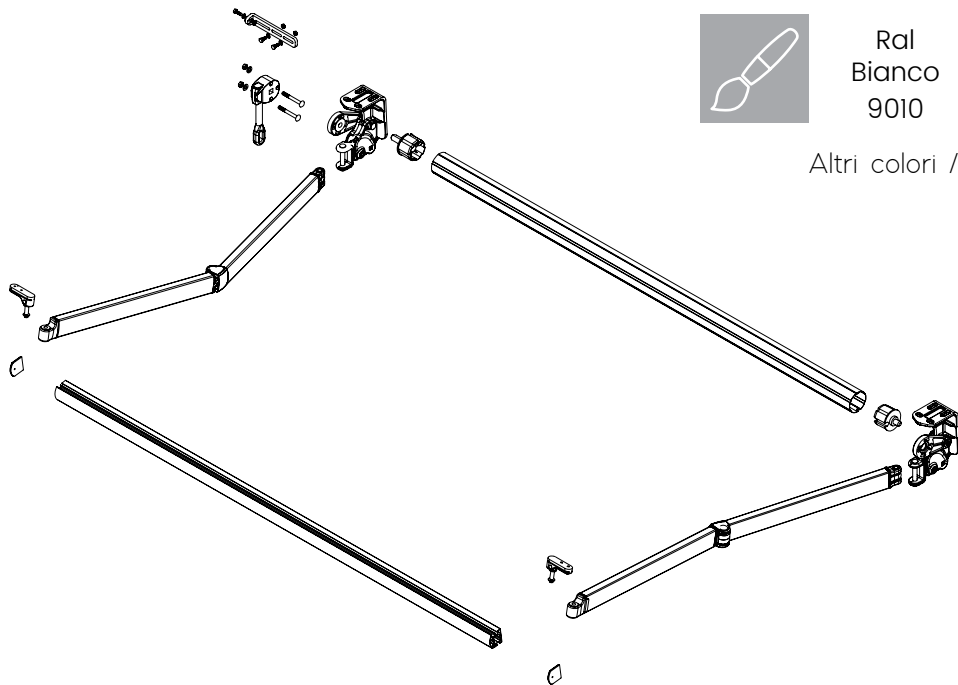

ECLISSE

Colori di serie / Standard color / Couleurs standard



Ral Bianco 9010	Ral Avorio 1013	Ral Marrone 8017	Ral Antracite
-----------------------	-----------------------	------------------------	------------------

Altri colori / Another colors / Autres couleurs +20%

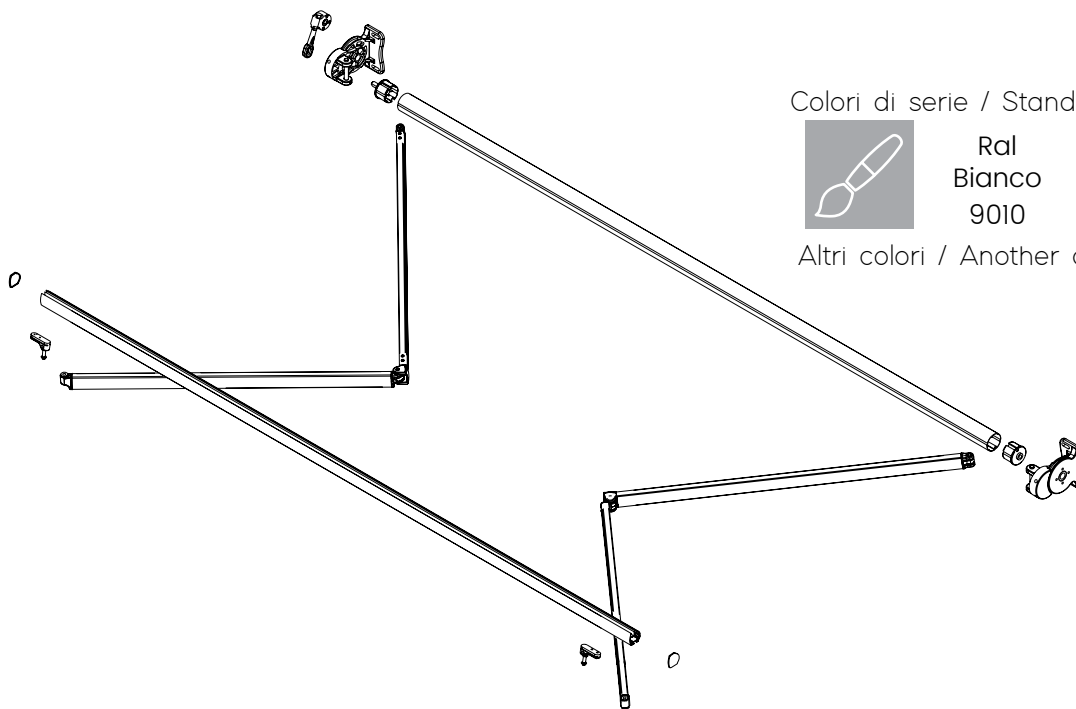

Disegno Figure Dessign	Descrizione Description Description	Informazioni Informations Information	Codice Article Code Code Article	U.M. Unit	Prezzo unitario Unit price Prix unitaire	Conf. std. Std. pack Cf. std
	Arganello 11:1 Awning gearbox 11:1 Treuil 11:1		ARG11:A	Pz		25
	Supporto parete soffitto leva incastro Support wall/ceiling liberty lever Snap Support mur/plafond à encastrement		TLOA001	Cp		10
	Supporto motore con soccorso Engine support with rescue Support moteur avec sauvetage		TLOA003	Pz		10
	Scivolo raccoglibraccio in nylon Slide tray arms Goulotte ramasse-bras en nylon		SCIV00001A	Cp		100
	Tappi per terminale 30600 con viti Caps for square bar 30600 with Screws Bouchons pour barre de charge 3060 avec vis		KIR0A025	Cp		50
	Scivolo snodato in alluminio Articulated slide lux Goulotte barre de charge		LUX0004A	Cp		25
	Tappi in nylon per tettino estruso Caps for roof extruded nylon Bouchons en nylon pour auvent extrudé		BQC0A029	Cp		20
	Stecchette per tettino Cues for roof Branchettes pour auvent		BQA0A029	Cp		10
	Staffe intermediale regolabili per tettino Intermediate bracket for roof Square bar Supports intermediaires réglables pour auvent		BQ40-017	Pz		10
	Tappo d.70 Con perno tondo 14x20 Plug with round pin dia 70 14x20 Embout ø 70 avec axe rond 14x20		TAPPT70	Pz		80
	Tappo perno quadro ø 70 Plug with square ø 70 Embout avec axe carré ø 70	13x55	TAPPQ70-13X55	Pz		80
	Supporto parete soffitto eclisse Support wall/ceiling eclisse Support mur/plafond eclisse		ECLI006A	Cp		10
	Tappo con foro Plug with hole Embout avec trou	ø 70	TAPF70	Pz		200
	Tappo perno quadro ø 70 Plug with square ø 70 Embout avec axe carré ø 70	13x70	TAPPQ70-13X70	Pz		80
	Piastrina in nylon con perno estraibile Plate nylon with removable pin Plaquette en nylon avec axe extraible		PES0005	Pz		100

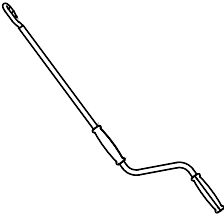
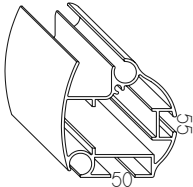
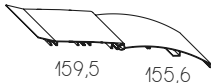
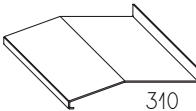
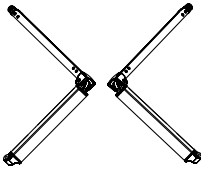
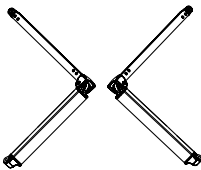
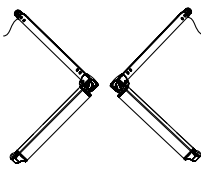
Disegno Figure Dessign	Descrizione Description Description	Informazioni Informations Information	Codice Article Code Code Article	U.M. Unit	Prezzo unitario Unit price Prix unitaire	Conf. std. Std. pack Cf. std
	Asta di manovra verniciata Crank handle Manivelle	Cm 100	AST0A100	Pz		10
		Cm 120	AST0A120			
		Cm 150	AST0A150			
		Cm 180	AST0A180			
		Cm 200	AST0A200			
		Cm 220	AST0A220			
		Cm 250	AST0A250			
	Terminale 30600 Terminal profile 30600 Barre de charge 30600	Cm 400	KIR4A001	Pz		10
		Cm 500	KIR5A001			
		Cm 600	KIR6A001			
		Cm 700	KIR7A001			
		1096gr/ml				
	Tettino estruso Roof extruded Auvent extrudé	Cm 400	BQC4A1ES	Pz		10
		Cm 500	BQC5A1ES			
		Cm 600	BQC6A1ES			
		Cm 700	BQC7A1ES			
1835gr/ml						
	Tettino piegato Roof allum. Bent Auvent plié	Cm 300	BQC3A1	Pz		10
		Cm 400	BQC4A1			
		Cm 500	BQC5A1			
		Cm 600	BQC6A1			
	Bracci a catena Arms with chain Bras à chaîne	Cm 160	KIR0A160	Cp		10
		Cm 185	KIR0A185			
		Cm 210	KIR0A210			
		Cm 235	KIR0A235			
		Cm 260	KIR0A260			
		Cm 285	KIR0A285			
		Cm 310	KIR0A310			
	Bracci a cavetto Arms with cable Bras à câble	Cm 160	CAV0A160	Cp		10
		Cm 185	CAV0A185			
		Cm 210	CAV0A210			
		Cm 235	CAV0A235			
		Cm 260	CAV0A260			
		Cm 285	CAV0A285			
		Cm 310	CAV0A310			
	Bracci led KIRO a catena Arms with chain Bras à chaîne	Cm 160	KIRO-LED-160A	Cp		10
		Cm 185	KIRO-LED-185A			
		Cm 210	KIRO-LED-210A			
		Cm 235	KIRO-LED-235A			
		Cm 260	KIRO-LED-260A			
		Cm 285	KIRO-LED-285A			
		Cm 310	KIRO-LED-310A			

Note

A large rectangular area with horizontal dotted lines, intended for writing notes.

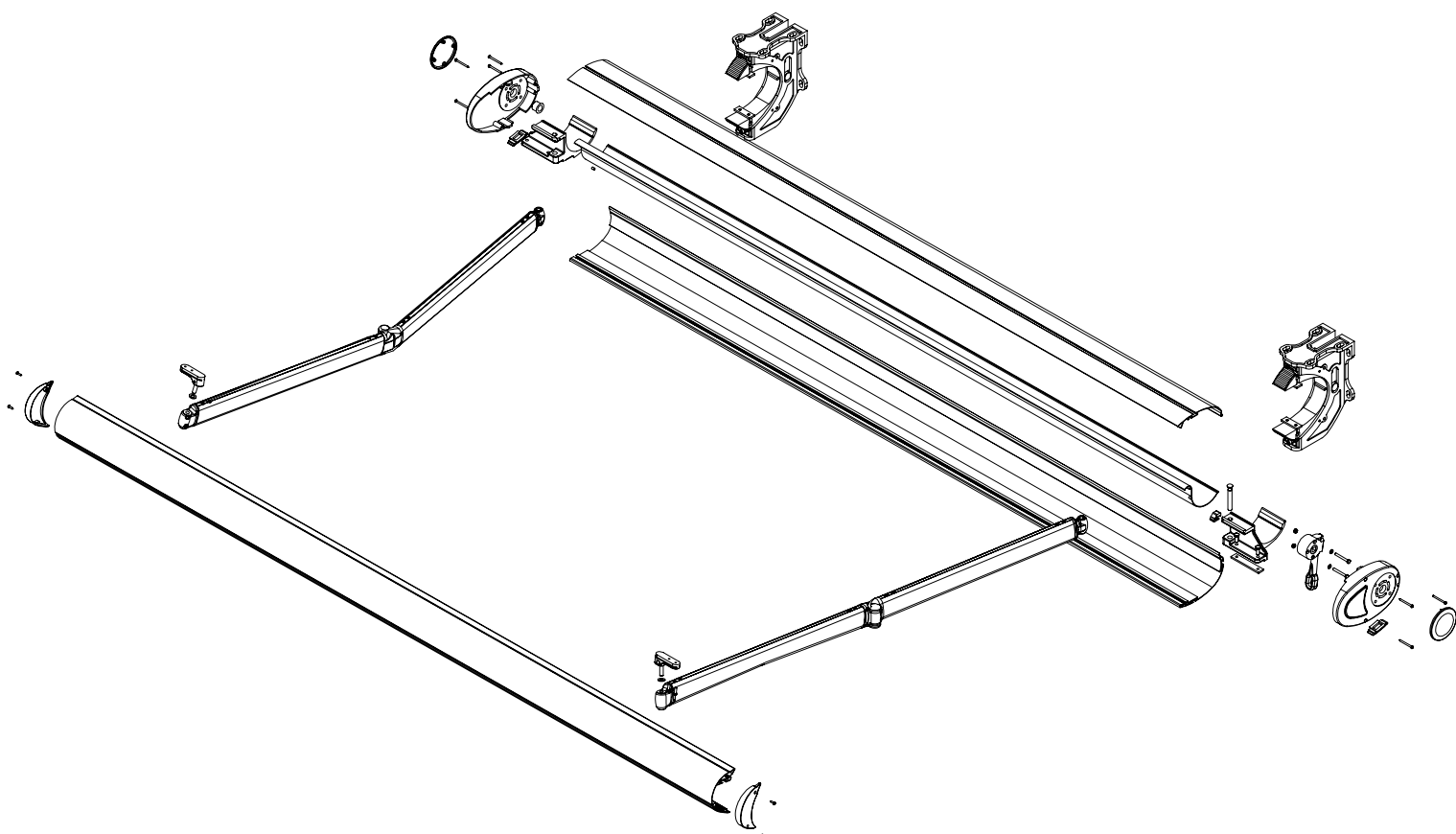

Colori di serie / Standard color / Couleurs standard



Ral Bianco 9010	Ral Avorio 1013	Ral Grigio 7035	Ral Antracite
-----------------------	-----------------------	-----------------------	------------------

Altri colori / Another colors / Autres couleurs +20%

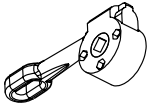
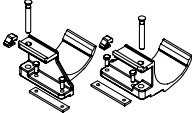
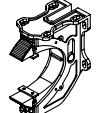
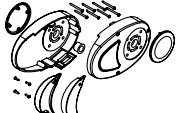
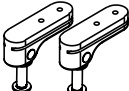
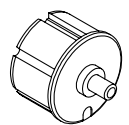
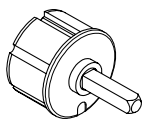
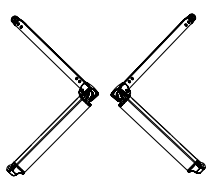
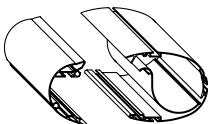
Disegno Figure Dessign	Descrizione Description Description	Informazioni Informations Information	Codice Article Code Code Article	U.M. Unit Unit price	Prezzo unitario Unit price Prix unitaire	Conf. std. Std. pack Cf. std
	Arganello 11:1 Awning gearbox 11:1 Treuil 11:1		ARGM1A	Pz		25
	Supporto braccio europa con scivolo Support arm europa with slide Support bras europa avec goulotte		ARM0A0001	Cp		10
	Supporto cassonetto europa Support box europa Support coffre		ARM0A0003PS	Pz		5
	Kit tappi cassonetto e terminale Kit caps with caps for terminal Profile Kit bouchons coffre et barre de charge		ARM0A0004	Cp		5
	Scivolo snodato in alluminio Articulated slide lux Goulotte barre de charge		LUX0004A	Cp		25
	Tappo d.70 Con perno tondo 14x20 Plug with round pin dia 70 14x20 Embout ø 70 avec axe rond 14x20 Tappo d.78 Con perno tondo 14x20 Plug with round pin dia 78 14x20 Embout ø 78 avec axe rond 14x20		TAPPT70 TAPPT78	Pz		80
	Tappo perno quadro ø 70 Plug with square ø 70 Embout avec axe carré ø 70 Tappo perno quadro ø 78 Plug with square ø 78 Embout avec axe carré ø 78	13x40	TAPPQ70-13x40	Pz		80
		Cm 160	TWS0A160			
		Cm 185	TWS0A185			
		Cm 210	TWS0A210			
	Bracci a catena twister Arms with chain twister Bras à chaîne twister	Cm 235	TWS0A235	Cp		10
		Cm 260	TWS0A260			
		Cm 285	TWS0A285			
		Cm 310	TWS0A310			
		Cm 360	TWS0A360			
	Kit profili europa 4000 (Cassonetto e terminale) kit profiles europa 4000 (Box and terminal profile) Kit profils europa 4000 (Coffre et barre de charge)	Cm 400	ARM4A005			
		Cm 500	ARM5A005	Pz		5
		Cm 600	ARM6A005			
		Cm 700	ARM7A005			
		7468gr/ml				

STAR BOX

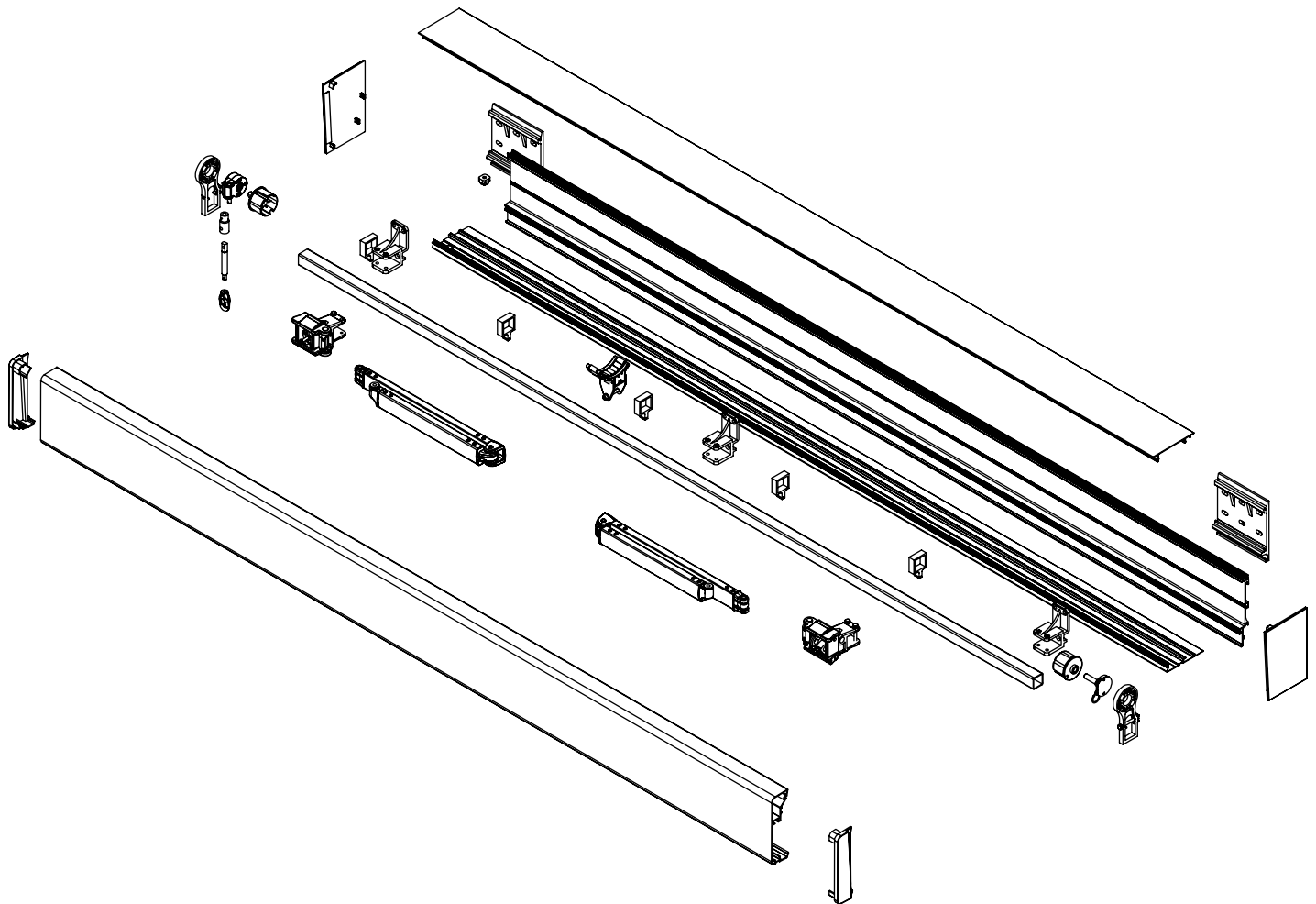

Colori di serie / Standard color / Couleurs standard



Ral
Bianco
9010

Ral
Avorio
1013

Ral
Marrone
8017

Ral
Antracite

Altri colori / Another colors / Autres couleurs +20%

Disegno Figure Dessign	Descrizione Description Description	Informazioni Informations Information	Codice Article Code Code Article	U.M. Unit Unit price	Prezzo unitario Unit price Prix unitaire	Conf. std. Std. pack Cf. std
	Arganello 11:1 Awning gearbox 11:1 Treuil 11:1		ARG11A	Pz		25
	Kit tappi cassonetto e terminale Kit caps with caps for terminal Profile Kit bouchons coffre et barre de charge		STBX-055	Pz		5
	Supporto parete Support wall Support mur		STBX-005	Pz		5
	Supporto braccio star box con scivolo Support arm star box with slide Support bras star box avec goulotte		STBX-051	Cp		5
	Supporto avvolgitore star box Support winder star box Support enrouleur star box		STBX-006	Cp		5
	Supporto bq star box Support bq star box Support bq star box		STBX-008	Cp		5
	Coperchio viti starbox Starbox screw cover Cache vis Starbox		STBX-041	Pz		5
	Attacco cassone sotto starbox Bin connection under starbox Connexion bac sous starbox		STBX-041	Pz		5
	Supporto tettino starbox Starbox roof support Support de toit Starbox		STBX-035	Pz		5
	Supporto compensatore star box Star box compensator support Support de compensateur étoile		STBX-044	Pz		5
	Fermo cass star box Star box box stop Butée de boîte étoile		STBX-007	Pz		5
	Tappo con foro Plug with hole Embout avec trou	Ø 70 Ø 78	TAPF70 TAPF78	Pz		80
	Tappo perno quadro Plug with square Embout avec axe carré	Ø 70 Ø 78	TAPPQ70-13x70 TAPPQ78-13x70	Pz		80
	Piastrina in nylon con perno estraibile Plate nylon with removable pin Plaque en nylon avec axe extraible		PCP00004	Pz		100

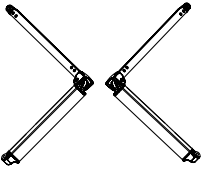
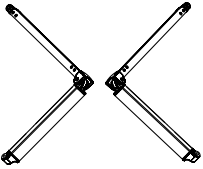
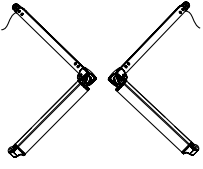
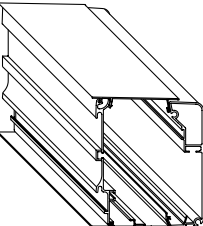
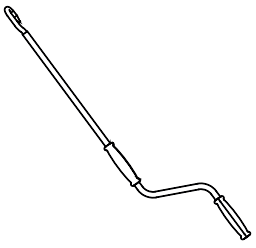
Disegno Figure Design	Descrizione Description Description	Codice Article Code Code Article	U.M. Unit	Prezzo unitario Unit price Prix unitaire	Conf. std. Std. pack Cf. std
	Bracci a catena Arms with chain Bras à chaîne	Cm 160 SBBQC160A	Cp		10
		Cm 185 SBBQC185A			
		Cm 210 SBBQC210A			
		Cm 235 SBBQC235A			
		Cm 260 SBBQC260A			
		Cm 285 SBBQC285A			
Cm 310 SBBQC310A					
	Bracci a cavetto Arms with cable Bras à câble	Cm 160 SBBQCAV0160A	Cp		10
		Cm 185 SBBQCAV0185A			
		Cm 210 SBBQCAV0210A			
		Cm 235 SBBQCAV0235A			
		Cm 260 SBBQCAV0260A			
		Cm 285 SBBQCAV0285A			
Cm 310 SBBQCAV0310A					
	Bracci led KIRO a catena Arms with chain Bras à chaîne	Cm 160 SBBQC160A-LED	Cp		10
		Cm 185 SBBQC185A-LED			
		Cm 210 SBBQC210A-LED			
		Cm 235 SBBQC235A-LED			
		Cm 260 SBBQC260A-LED			
		Cm 285 SBBQC285A-LED			
Cm 310 SBBQC310A-LED					
	Kit profili Star Box 5 pezzi Profiles Kit Star Box 5 pieces Kit de profilés Star Box 5 pièces	Cm 400 KIT-STBX4A	Pz		5
		Cm 500 KIT-STBX5A			
		Cm 600 KIT-STBX6A			
		Cm 700 KIT-STBX7A			
		10992gr/ml			
	Asta di manovra verniciata Crank handle Manivelle	Cm 100 AST0A100	Pz		10
		Cm 120 AST0A120			
		Cm 150 AST0A150			
		Cm 180 AST0A180			
		Cm 200 AST0A200			
		Cm 220 AST0A220			
		Cm 250 AST0A250			
Cm 300 AST0A300					

Note

A large rectangular area with horizontal dotted lines, intended for writing notes.

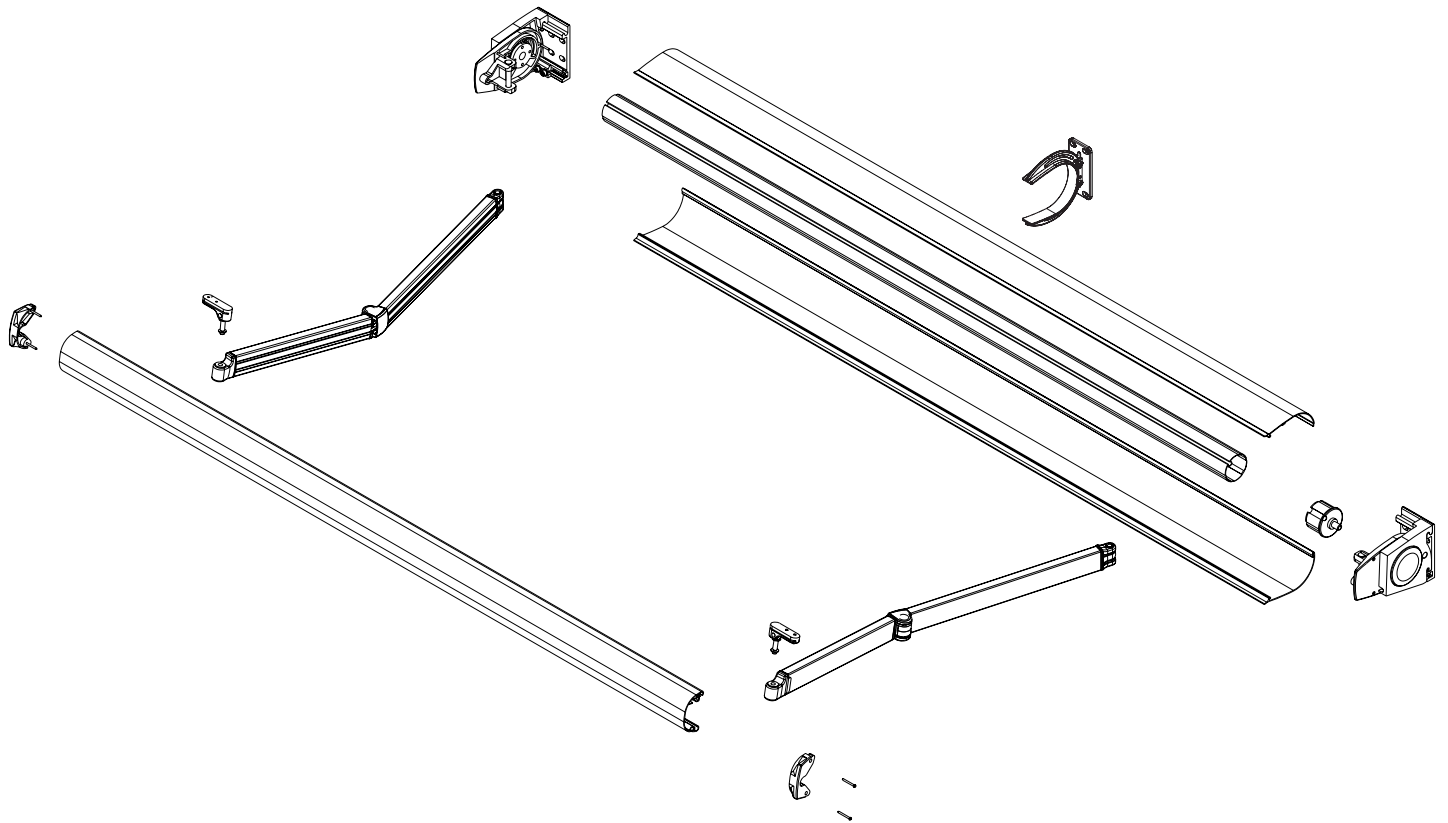

Colori di serie / Standard color / Couleurs standard



Ral
Bianco
9010



Ral
Avorio
1013

Ral
Marrone
8017

Ral
Grigio
7035

Ral
Antracite

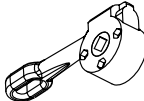
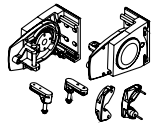
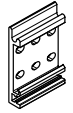
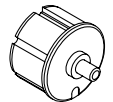
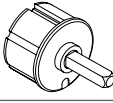
Altri colori / Another colors / Autres couleurs +20%

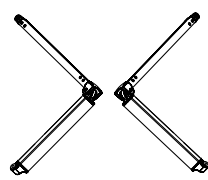
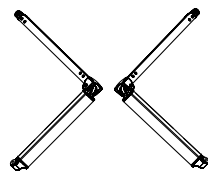
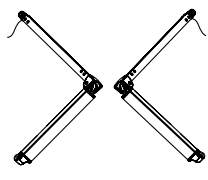
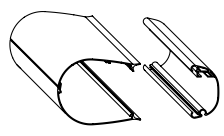
Disegno Figure Dessign	Descrizione Description Description	Informazioni Informations Information	Codice Article Code Code Article	U.M. Unit	Prezzo unitario Unit price Prix unitaire	Conf. std. Std. pack Cf. std
	Arganello 11:1 Awning gearbox 11:1 Treuil 11:1		ARGM11A	Pz		25
	Kit supporti verona parete/soffitto Kit support verona wall/ceiling Kit supports verona mur/plafond		VERO-001	Pz		5
	Supporto parete soffitto Support wall/ceiling Support mur/plafond		F430A-001	Pz		5
	Tappo Con perno tondo 14x20 Plug with round pin 14x20 Embout avec axe rond 14x20	Ø 70 Ø 78	TAPPT70 TAPPT78	Pz		80
	Tappo perno quadro Plug with square Embout avec axe carré	Ø 70 Ø 78	TAPPQ70-13x70 TAPPQ78-13x70	Pz		80
	Supporto centrale cassonetto Central support box Boîte de support centrale		MILA-033	Pz		10
	Bracci a catena Arms with chain Bras à chaîne	Cm 160 Cm 185 Cm 210 Cm 235 Cm 260 Cm 285 Cm 310	MIL0A160 MIL0A185 MIL0A210 MIL0A235 MIL0A260 MIL0A285 MIL0A310	Cp		10
	Bracci a cavetto Arms with cable Bras à câble	Cm 160 Cm 185 Cm 210 Cm 235 Cm 260 Cm 285 Cm 310	MIL0A160C MIL0A185C MIL0A210C MIL0A235C MIL0A260C MIL0A285C MIL0A310C	Cp		10
	Bracci led KIRO a catena Arms with chain Bras à chaîne	Cm 160 Cm 185 Cm 210 Cm 235 Cm 260 Cm 285 Cm 310	KIRO-LED-160A KIRO-LED-185A KIRO-LED-210A KIRO-LED-235A KIRO-LED-260A KIRO-LED-285A KIRO-LED-310A	Cp		10
	Kit profili verona Kit profiles verona Kit profils verona	Cm 300 Cm 400 Cm 500	ML3A001 ML4A001 ML5A001	Pz		5
		4353gr/ml				

CAPPOTTINE



Elba / Capri

Giglio

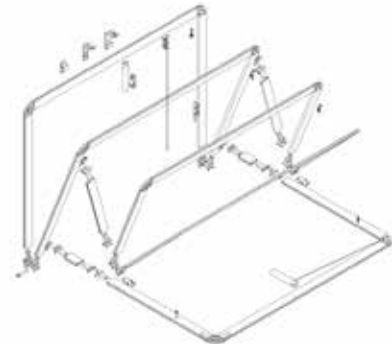

Piramide

Ischia

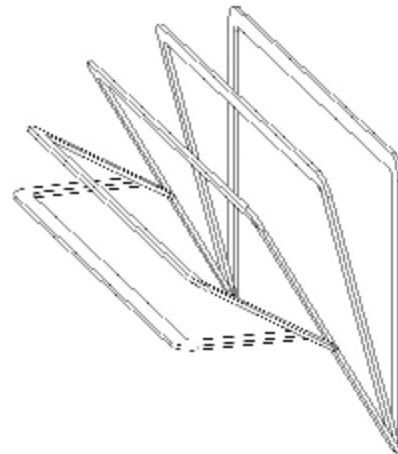
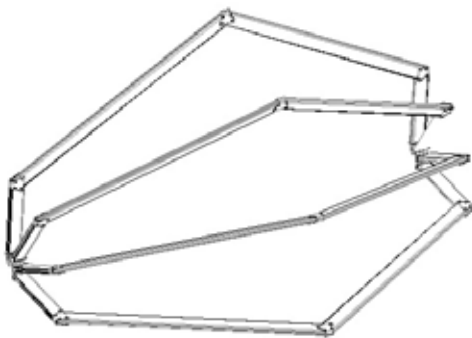

Layla

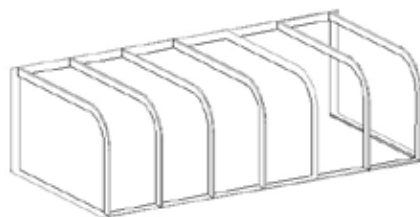

Colori di serie / Standard color / Couleurs standard



Ral Bianco 9010	Ral Antracite	Ral Avorio 1013	Ral Marrone 8017	Ral Grigio 7035
-----------------------	------------------	-----------------------	------------------------	-----------------------

Ral
Argento
9006

Altri colori / Another colors / Autres couleurs +20%

Colori di serie / Standard color / Couleurs standard

Mod. Capri



Ral Bianco 9010	Ral Avorio 1013	Ral Grigio 7035
-----------------------	-----------------------	-----------------------

Altri colori / Another colors / Autres couleurs +20%

CAPPOTTINE



Rotonda mod. A

Rotonda mod. B

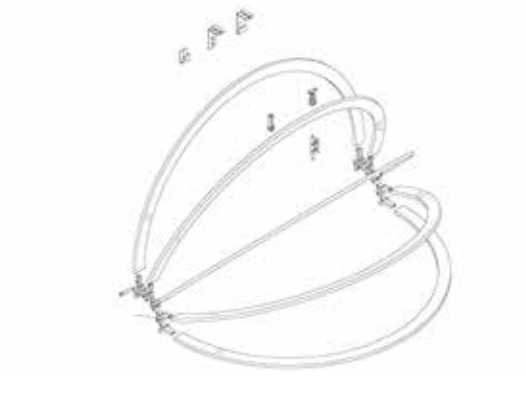
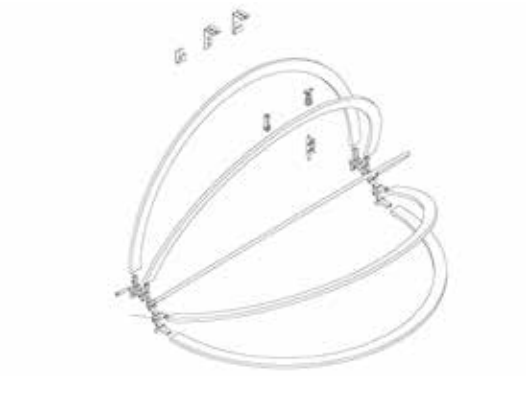

Tr fissa mod. A

Tr fissa mod. b

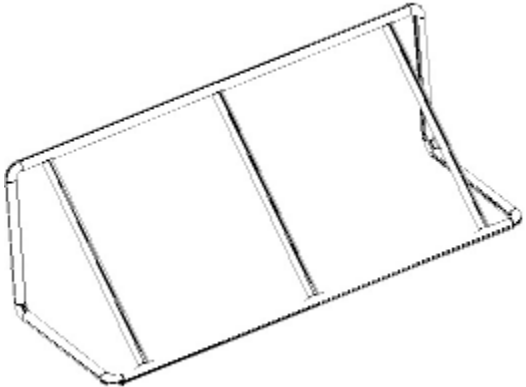
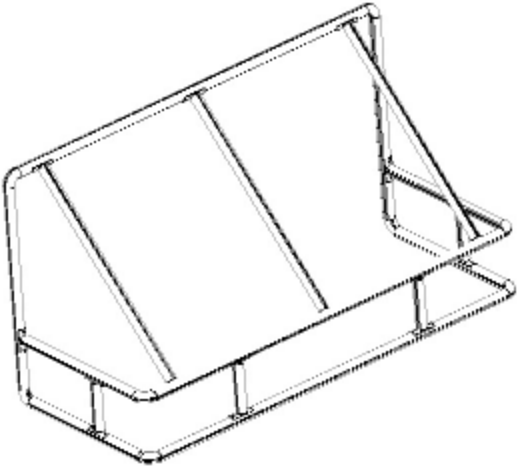







Colori di serie / Standard color / Couleurs standard

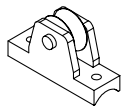
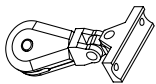
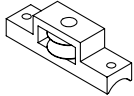
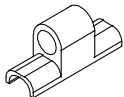
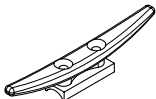
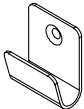
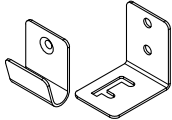
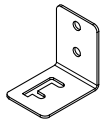

Ral Bianco 9010	Ral Argento 9006	Ral Avorio 1013	Ral Marrone 8017	Ral Grigio 7035
-----------------------	------------------------	-----------------------	------------------------	-----------------------

Altri colori / Another colors / Autres couleurs +20%

Disegno Figure Dessign	Descrizione Description Description	Informazioni Informations Information	Codice Article Code Code Article	U.M. Unit	Prezzo unitario Unit price Prix unitaire	Conf. std. Std. pack Cf. std
	Curva 90° (composta da 2 pz.) Curve 90° (composed of 2 pcs) Courbe 90° (compose par 2 piece)	Alluminio	CAP0A001/1	Pz	€	200
	Inserto in pvc per curve Insert bracket pvc for curves Insert en pvc pour courbes	PVC	CAP0A027	Pz		100
	Cerniera terminale maschio Terminal hinge male Charnière terminale mâle	Alluminio	CAP0A002/1	Pz		200
	Cerniera intermedia maschio-femmina Hinge intermediate male-female Charnière intermediaire mâle-femelle	Alluminio	CAP0A003/1	Pz		200
	Cerniera terminale femmina Terminal hinge female Charnière terminale femelle	Alluminio	CAP0A004/1	Pz		200
	Cerniera battuta parete Hinge bar wall Charnière battue mural	Alluminio	CAP0A005/1	Pz		200
	Cerniera battuta maschio Hinge bar male Charnière battue mâle	Alluminio	CAP0A006/1	Pz		200
	Ribattino per cerniera Rivet hinge Rivet pour charnière	Zincato Nylon	CAP00014 CAP0A014	Pz		100
	Cerniera 4 raggi profilo 15x45 Hinge 4 rays for profile 15x45 Charnière 4 rayons profil 15x45	Nylon	CAP0A040	Cp		20
	Cerniera 5 raggi profilo 15x45 Hinge 5 rays for profile 15x45 Charnière 5 rayons profil 15x45	Nylon	CAP0037	Cp		20
	Cerniera 4 raggi elba Hinge 4 rays for elba Charnière 4 rayons elba	Alluminio	CAP00031	Cp		10
	Cerniera 5 raggi elba Hinge 5 rays for elba Charnière 5 rayons elba	Alluminio	CAP0A033	Cp		10
	Giunto a "T" Insert bracket a "T" Support à "T"		CAP0A038	Pz		50
	Curva in per profilo 15x45 Curve for profile 15x45 Courbe pour profil 15x45	Nylon	CAP0A036	Pz		50
	Giunto angolare Coupling angular Jonction angulaire		CAP0A019	Pz		50
	Curva regolabile per profilo 14,4x50 Adjustable curve for profile 14,4x50 Courbe réglable pour profil 14,4,x50	Alluminio	CAP00036A	Pz		10

Disegno Figure Dessign	Descrizione Description Description	Informazioni Informations Information	Codice Article Code Code Article	U.M. Unit Unit	Prezzo unitario Unit price Prix unitaire	Conf. std. Std. pack Cf. std
	Carrucola grande fissa Large pulley fixed Grande poulie fixe	Nylon	CAP0A007	Pz		200
	Carrucola snodata Swivel pulley Poulie à rotule	Inox Nylon	CAP0A008/1 CAP0A008	Pz		200
	Carrucola piccola per raggiera Small pulley for rays Petite poulie pour rayon	Nylon	CAP0A009	Pz		200
	Fermacorda Rope stops Arrêt-corde	Nylon	CAP0A015	Pz		200
	Maniglia avvolgicorda Handle wrap rope Taquet pour enroulage corde	Nylon	CAP0A010	Pz		100
	Supporto a "U" Support a "U" Support à "U"		CAP0A011	Pz		200
	Supporto a "U" rinforzato per soffitto Regolabile Support a "U" adjustable reinforced For ceiling with bolt Support à "U" renforcé pour plafond réglable		CAP0A012	Pz		50
	Staffa a "L" regolabile Bracket a "L" adjustable Support à "L" réglable		CAP0A039	Pz		50
	Tappo per profilo cappottina Caps for profile cappottina Bouchons pour profil cappottina	Nylon	CAP00037	Pz		20
	Tappo per profilo rinforzato cappottina Plug for profile reinforced cappottina Bouchon pour profil renforcé	Nylon	CAP0A030	Pz		20
	Kit accessori capri 4 raggi Kit accessories capri 4 rays Kit accessoires capri 4 rayons Kit accessori capri 5 raggi Kit accessories capri 5 rays Kit accessoires capri 5 rayons	Nylon	KITCR4R001 KITCR5R001	Pz		5
	Kit accessori elba 4 raggi Kit accessories elba 4 rays Kit accessoires elba 4 rayons Kit accessori elba 5 raggi Kit accessories elba 5 rays Kit accessoires elba 5 rayons	Alluminio	KITCA4R001 KITCA5R001	Pz		5
	Kit accessori giglio 4 raggi Kit accessories giglio 4 rays Kit accessoires giglio 4 rayons Kit accessori giglio 5 raggi Kit accessories giglio 5 rays Kit accessoires giglio 5 rayons	Alluminio	KITGE4R001 KITGE5R001	Pz		5
	Kit accessori ischia 4 raggi Kit accessories ischia 4 rays Kit accessoires ischia 4 rayons Kit accessori ischia 5 raggi Kit accessories ischia 5 rays Kit accessoires ischia 5 rayons	Alluminio	KITLO4R001 KITLO5R001	Pz		5

Disegno Figure Dessign	Descrizione Description Description	Informazioni Informations Information	Codice Article Code Code Article	U.M. Unit Unit	Prezzo unitario Unit price Prix unitaire	Conf. std. Std. pack Cf. std
------------------------------	---	---	--	----------------------	--	------------------------------------

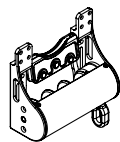

Kit arganello per cappottina
 Kit awning gearbox for cappottina
 Kit treuil pour store corbeille
 ESCLUSO ASTA DI MANOVRA - WITH OUT CRANK HANDLE - SANS MANIVELLE

CAP0A017

Pz

5

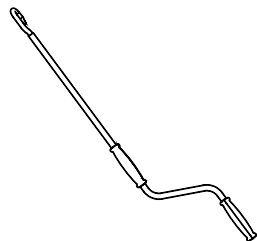

Asta di manovra verniciata
 Crank handle
 Manivelle

Cm 100 AST0A100

Cm 120 AST0A120

Cm 150 AST0A150

Cm 180 AST0A180

Cm 200 AST0A200

Cm 220 AST0A220

Cm 250 AST0A250

Cm 300 AST0A300

Pz

10

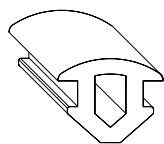

Guarnizione x profilo 14,4x50 elba
 Profile pvc for finish 14,4x50 elba
 Joint pour profil 14,4x50 elba
 Guarnizione x profilo 15x45 capri
 Profile pvc for finish 15x45 capri
 Joint pour profil 15x45 capri

CAP00021

MI

150

CAP0A023

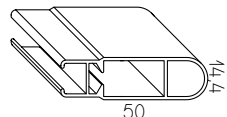

Profilo principale 14,4x50
 Profile basic 14,4x50
 Profil principal 14,4x50

Cm 700

CAP7A024

Pz

10

441gr/ml

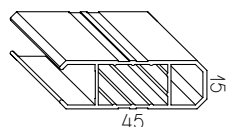

Profilo cappottina capri 15x45
 Profile cappottina capri 15x45
 Profil capri 15x45

Cm 700

CAP7A041

Pz

10

397gr/ml

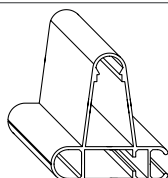

Profilo rinforzato
 Profile reinforced
 Profil renforcé

Cm 700

CAP7A029

Pz

10

871gr/ml

Note

A large rectangular area with horizontal dotted lines, intended for writing notes.



Tipo-Type A

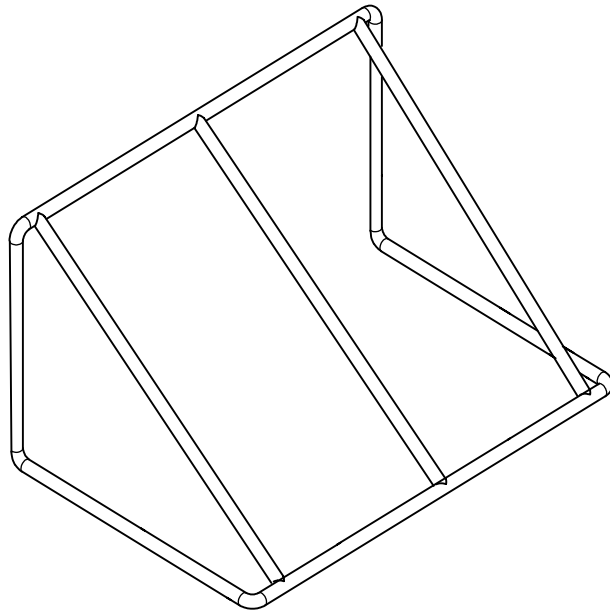

Tipo-Type B

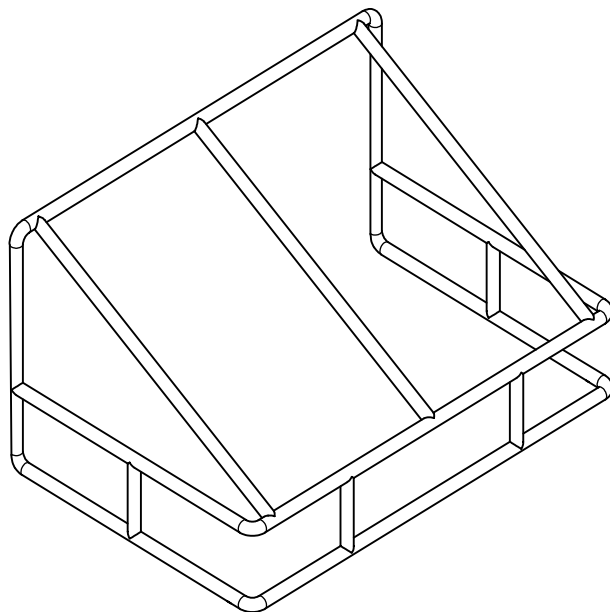

Colori di serie / Standard color / Couleurs standard



Ral
Bianco
9010

Altri colori / Another colors / Autres couleurs +20%

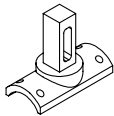
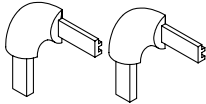
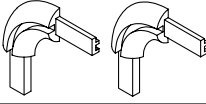
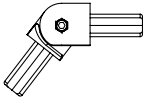
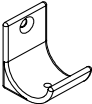
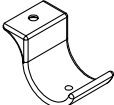
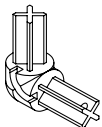
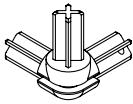
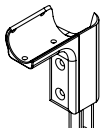
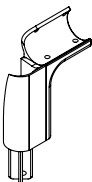
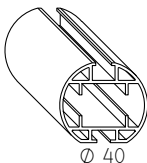
Disegno Figure Dessign	Descrizione Description Description	Informazioni Informations Information	Codice Article Code Code Article	U.M. Unit Unit price	Prezzo unitario Unit price Prix unitaire	Conf. std. Std. pack Cf. std
	Supporto a "T" Asia Support a "T" Asia Support à "T" Asia		AM0A001	Pz	€	10
	Curva asia (composta da 2 pz) Curve asia (composed of 2 pcs) Courbe asia (composé de 2 pièces)		AM0A002	Pz	€	10
	Curva con scanalatura asia Support for wall asia Courbe avec rainure asia		AM0A006	Pz	€	10
	Curva snodata asia Jointed curve asia Courbe articulée asia		ASIA 017	Pz	€	10
	Supporto a parete asia Support for wall asia Support mural asia		AM0A003	Pz	€	10
	Supporto a soffitto asia Support for ceiling asia Support plafond asia		AM0A004	Pz	€	50
	Angolare a 2 Corner 2 Coin 2		ASIA-007	Pz	€	50
	Angolare a 3 Corner 3 Coin 3		ASIA-006	Pz	€	50
	Inserto A L Asia Sup Dx Insert A L Asia Sup Right Insert A L Asia Sup Droit		ASIA-004	Pz	€	50
	Inserto A L Asia Sup Sx Insert A L Asia Sup Sx Insert A L Asia Sup Sx		ASIA-005	Pz	€	50
	Terminale 31266 Terminal profile 31266 Barre de charge 31266	Cm 700 793gr/ml	GALL7A003	Pz	€	

ECO TUNNEL

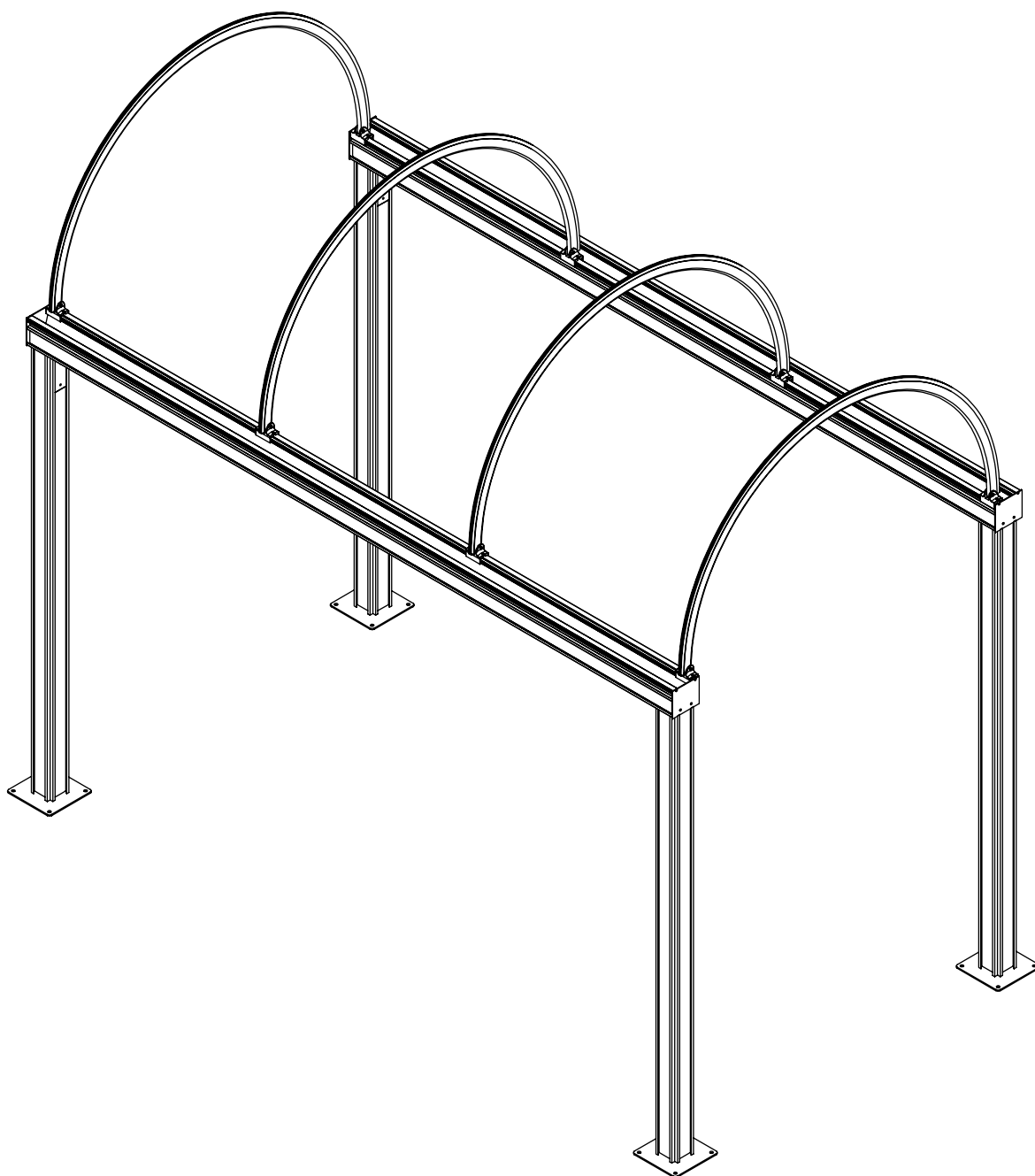





Colori di serie / Standard color / Couleurs standard

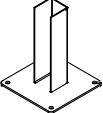
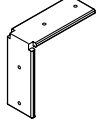
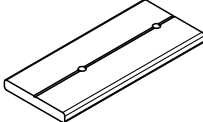

Ral
Bianco
9010

Altri colori / Another colors / Autres couleurs +20%

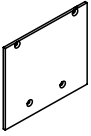
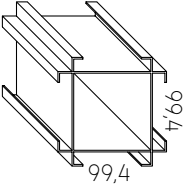
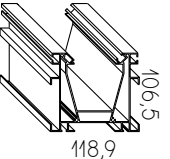
Disegno Figure Dessign	Descrizione Description Description	Informazioni Informations Information	Codice Article Code Code Article	U.M. Unit Unit price	Prezzo unitario Unit price Prix unitaire	Conf. std. Std. pack Cf. std
	Piede tunnel Leg eco tunel Pied tunnel		GALL0A010	Pz	€	4
	Staffa 90° 170x170 Bracket 90° 170x170 Support 90° 170x170		GALL0A007	Pz		8
	Giunzione profilo portante Junction carrier profile Jonction profil principal		GALL0A005	Pz		8
	Supporto centina fisso Support center fixed Support courbe fixe		EGALL0A002	Pz		50
	Supporto centina regolabile Support center adjustable Support courbe réglable		EGALL0A003	Pz		20
	Gancio laterale girevole Side hook gazebo tent Crochet pour gazebo		GAZ00014	Pz		40
	Carrello scorrevole per binario in Alluminio Sliding trolley for track allum. Chariot coulissant pour rail en aluminium Carrello scorrevole per profilo Gazebo Sliding trolley for track gazebo Chariot coulissant pour profil gazebo		GAZ00055 GAZ00056	Pz		100
	Tappo canale Cap canal eco tunnel Bouchon gouttière		GALL0A008	Pz		20
	Profilo colonna Profile column Profil jambe	Cm 700 2180gr/ml	GALL7A001	Pz		10
	Profilo portante piccolo Profil carrier small Profil principal	Cm 700 1717gr/ml	GALL7A002	Pz		10

SCREENS

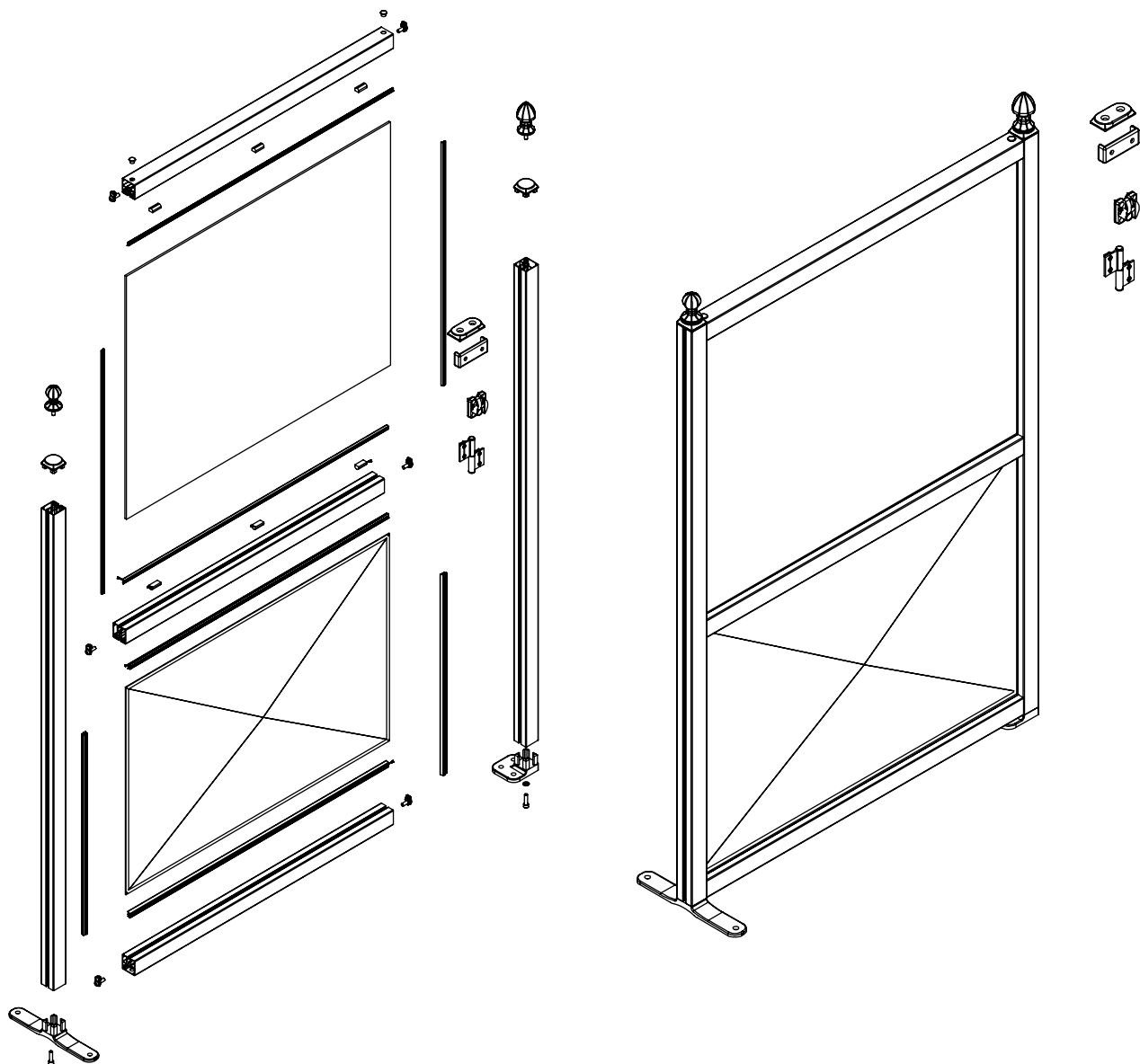

Colori di serie / Standard color / Couleurs standard



Ral
Antracite

Altri colori / Another colors / Autres couleurs +20%

Disegno Figure Design	Descrizione Description Description	Informazioni Informations Information	Codice Article Code Code Article	U.M. Unit Unit price	Prezzo unitario Unit price Prix unitaire	Conf. std. Std. pack Cf. std
	Piedino Leg Pied		SCRE-001	Pz	€	10
	Piede autoportante Leg self-supporting Pied auto-supportant		SCRE-005	Pz	€	10
	Fermo completo Bracket fixed kit Arrêt complet		SCRE-004	Pz	€	10
	Tappo Cap Bouchon		SCRE-002	Pz	€	10
	Spessore per vetro Thicknes for glass Epaisseur pour verre		SCRE-006	Pz	€	50
	Punta Tip Pointe		SCRE-007	Pz	€	10
	Palla Ball Boule		SCRE-008	Pz	€	10
	Staffa doppio modulo Double bracket form Support double module		SCRE-019	Pz	€	10
	Tappino Cap mini Bouchon		MAN0A002	Pz	€	50
	Tappo modulo doppio Cap double module Bouchon double module		SCRE-018	Pz	€	10
	Guarnizione vetro mm.2 Glass gasket mm2 Joint verre 2 mm		GUARMM2	MI	€	400
	Guarnizione policarbonato mm.4 Polycarbonate gasket mm4 Joint de polycarbonate mm.4		GUARMM4			250
	Guarnizione pannello mm.7 Panel gasket mm7 Joint panneau 7 mm		GUARMM7	MI	€	125

Disegno Figure Dessign	Descrizione Description Description	Informazioni Informations Information	Codice Article Code Code Article	U.M. Unit Unit	Prezzo unitario Unit price Prix unitaire	Conf. std. Std. pack Cf. std
------------------------------	---	---	--	----------------------	--	------------------------------------

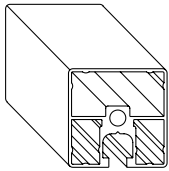

Profilo 1 gola
Profile with 1 gorge
Profil avec 1 gorge

1336gr/ml

SCRE6N-011

Pz

10

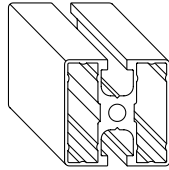

Profilo 2 gole
Profile with 2 gorges
Profil avec 2 gorges

1509gr/ml

SCRE6N-010

MI

10

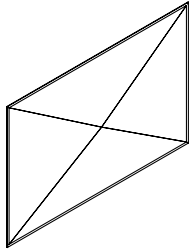

Pannello in lamiera zincata verniciata I.50Xh.65
Panel sheet zinc painted I.50Xh.65
Panneau en tole galvanisée I.50Xh.65
Pannello in lamiera zincata verniciata I.100Xh.66
Panel sheet zinc painted I.100Xh.66
Panneau en tole galvanisée I.100Xh.66

PAN-ZINC50

MI

5

PAN-ZINC100

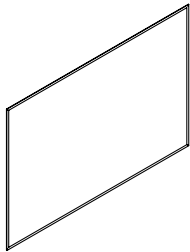

Pannello in alluminio I.50Xh.65
Allum. Panel I.50Xh.65
Panneau en aluminium I.50Xh.65
Pannello in alluminio I.100Xh.65
Allum. Panel I.100Xh.65
Panneau en aluminium I.100Xh.65

Cm 500

PAN-ALL50

MI

5

Cm 700

PAN-ALL100

Note

A large rectangular area with horizontal dotted lines, intended for writing notes.

VETRATA SCORREVOLE

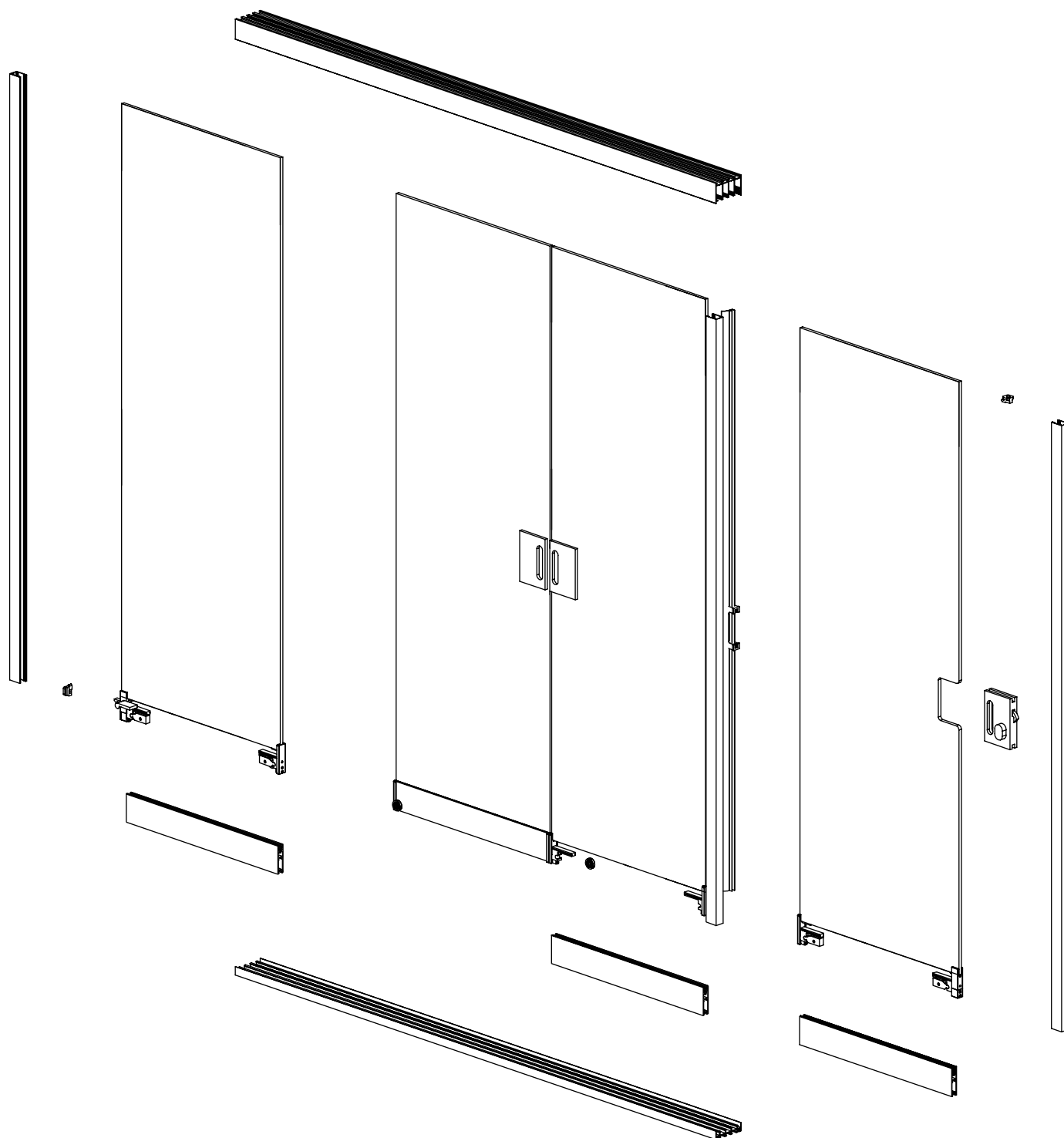

Colori di serie / Standard color / Couleurs standard





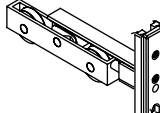
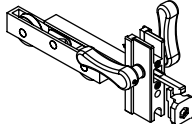
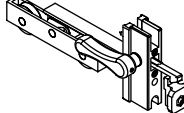
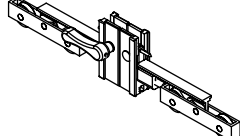
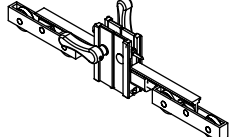
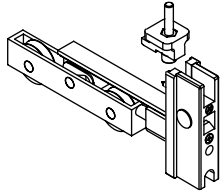
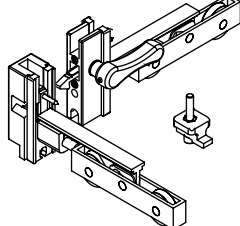
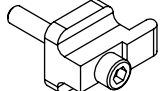
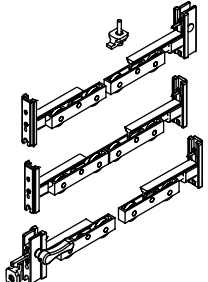
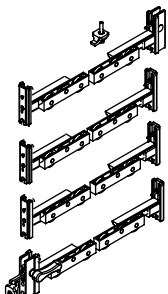

Ral	Ral	Ral
Bianco	Avorio	Marrone
9010	1013	8017

Ral	Ral
Antracite	Corten

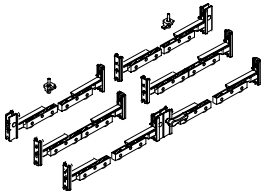
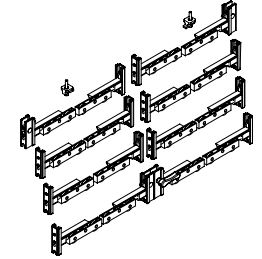
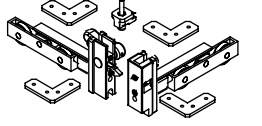
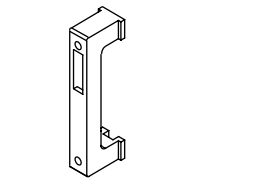
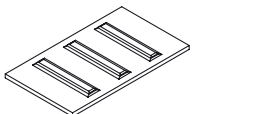
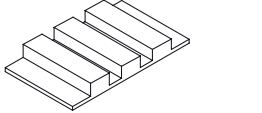
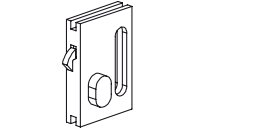
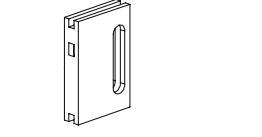
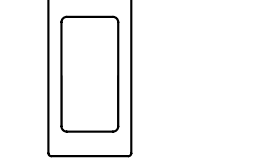
Altri colori / Another colors / Autres couleurs +20%

Disegno Figure Design	Descrizione Description Description	Informazioni Informations Information	Codice Article Code Code Article	U.M. Unit Unit price	Prezzo unitario Unit price Prix unitaire	Conf. std. Std. pack Cf. std
	Carrello scorrevole intermedio Intermediate sliding trolley Chariot coulissant intermédiaire		VETR-043	Pz		
	Carrello scorrevole laterale 2 leve Side sliding trolley 2 levers Chariot coulissant latéral 2 leviers		VETR-041	Pz		
	Carrello scorrevole laterale 1 leva Side sliding trolley 1 lever Chariot coulissant latéral 1 levier		VETR-045	Pz		
	Carrelli apertura centrale 1 leva Central opening trolleys 1 lever Chariots à ouverture centrale 1 levier		VETR-042	Pz		10
	Carrelli apertura centrale 2 leve Central opening trolleys 2 levers Chariots à ouverture centrale 2 leviers		VETR-047	Pz		10
	Carrelli fisso Trolleys fixed Chariots fixes		VETR-044	Pz		10
	Carrelli vetrata angolare Angular glass trolleys Chariots à verres angulaires		VETR-049	Pz		10
	Kit fermavetro Glass retainer kit Kit de retenue de verre		VETR-026	Pz		50
	Kit apertura laterale 3 vie 3-way side opening kit Kit ouverture latérale 3 voies		KIT-LAT-3VIE	Pz		50
	Kit apertura laterale 4 vie 4-way side opening kit Kit ouverture latérale 4 voies		KIT-LAT-4VIE	Pz		50

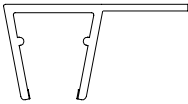
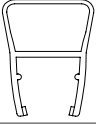
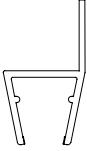
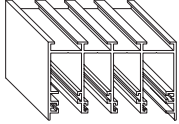
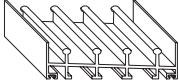
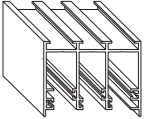
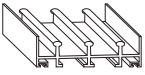
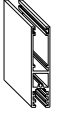
Disegno Figure Dessign	Descrizione Description Description	Informazioni Informations Information	Codice Article Code Code Article	U.M. Unit Unit	Prezzo unitario Unit price Prix unitaire	Conf. std. Std. pack Cf. std
	Kit apertura centrale 3 vie 3-way central opening kit Kit ouverture centrale 3 voies		KIT-CEN-3VIE	Pz	€	50
	Kit apertura centrale 4 vie 4-way central opening kit Kit ouverture centrale 4 voies		KIT-CEN-4VIE	Pz	€	50
	Kit apertura angolare Angular opening kit Kit d'ouverture angulaire		KIT-VETRANG	Pz	€	50
	Kit aggancio serratura laterale Side lock coupling kit Kit d'accouplement à verrouillage latéral		VETR-011	Pz	€	10
	Spessore 4 vie 4 way thickness Épaisseur 4 voies		VETR-014	Pz	€	10
	Attacco spessore 4 vie 4 ways thickness connection Connexion à 4 épaisseurs		VETR-015	Pz	€	50
	Serratura con chiave Lock with key Serrure avec clé	Inox	GHSLIN	Pz	€	1
	Controcartella serratura Lock counterfolder Verrouiller le contre-dossier	Inox	GHSL2N	Pz	€	1
	Maniglia adesiva rettangolare Rectangular adhesive handle Manche adhésif rectangulaire	Inox	RH01Q	Pz	€	1
	Spazzolino tcl mm 11 Brush tcl mm 11 Brosse tcl mm 11		TCL-016	MI	€	650

Disegno Figure Design	Descrizione Description Description	Informazioni Informations Information	Codice Article Code Code Article	U.M. Unit Unit price	Prezzo unitario Unit price Prix unitaire	Conf. std. Std. pack Cf. std
	Guarnizione con aletta laterale Seal with flap Joint avec rabat	CM 300	VAI37	Pz	€	10
	Guarnizione a palloncino Balloon seal Joint de ballon	CM 300	VAI35	Pz	€	5
	Guarnizione con aletta verticale Seal with flap Joint avec rabat	CM 300	FAV0001	Pz	€	5
	Guida soffitto 4 vie 4-way ceiling guide Guide de plafond à 4 voies	CM 400	VETR405A003	Pz	€	10
		CM 700	VETR7A003 2502gr/ml			
	Guida a terra 4 vie 4-way ground guide Guide au sol à 4 voies	CM 400	VETR405A004	Pz	€	10
		CM 700	VETR7A004 1461gr/ml			
	Guida soffitto 3 vie 3-way ground guide Guide au sol à 3 voies	CM 500	VETR505A006	Pz	€	10
		CM 600	VETR605A006 1997gr/ml			
	Guida a terra 3 vie 3-way ground guide Guide au sol à 3 voies	CM 500	VETR505A005	Pz	€	10
		CM 600	VETR605A005 1175gr/ml			
	Profilo vetro Glass profile Profil en verre	CM 700	VETR7A002	Pz	€	10
	Profilo a "u" "U" profile Profil "U"	CM 500	VETR5A001	Pz	€	10
		CM 600	VETR6A001			
		CM 700	VETR7A001 491gr/ml			

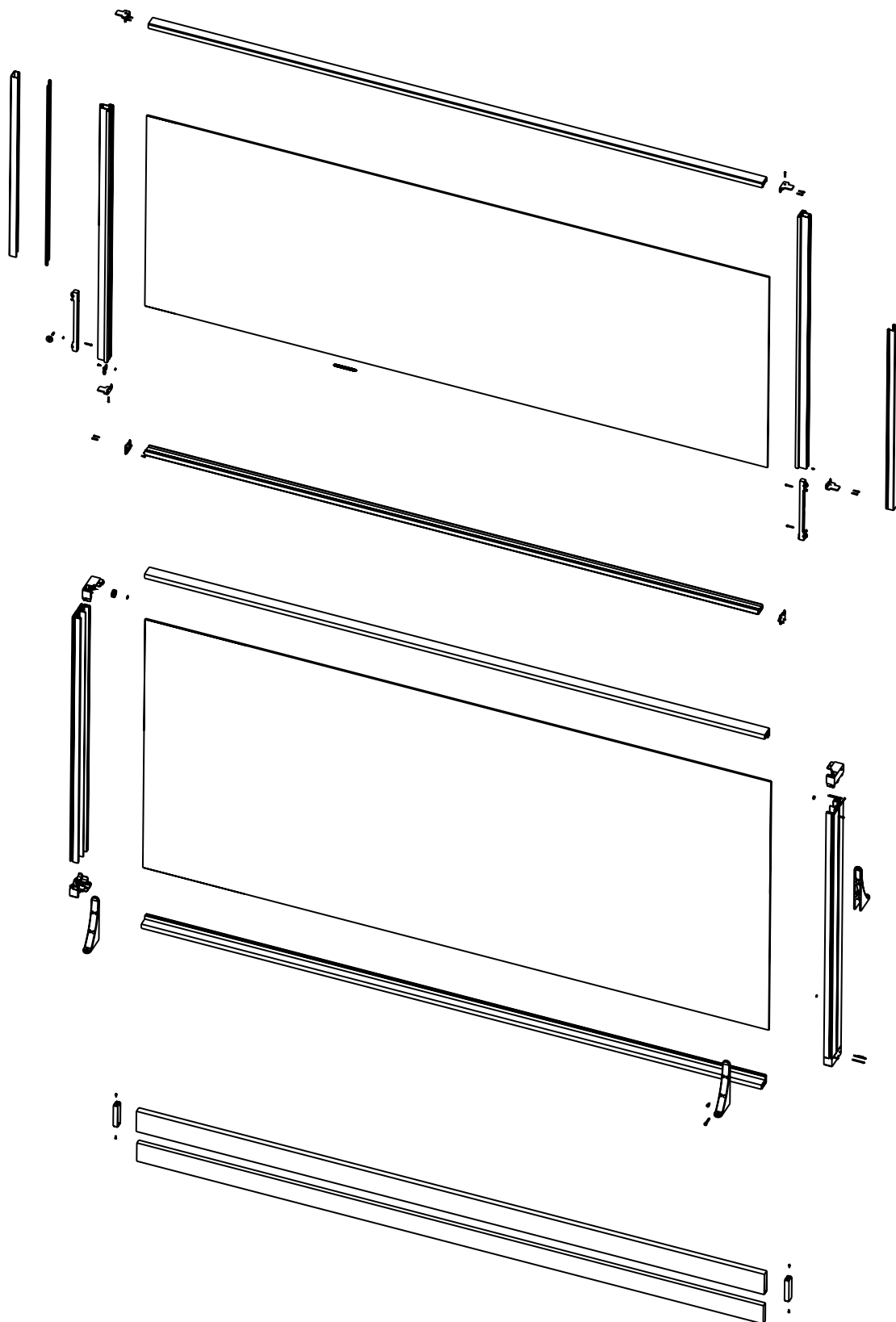

Colori di serie / Standard color / Couleurs standard





Ral	Ral	Ral
Bianco	Avorio	Marrone
9010	1013	8017

Ral	Ral
Antracite	Corten

Altri colori / Another colors / Autres couleurs +20%

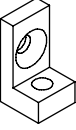
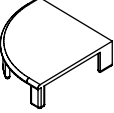
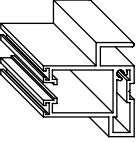
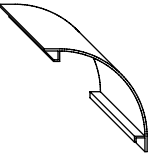
Disegno Figure Dessign	Descrizione Description Description	Informazioni Informations Information	Codice Article Code Code Article	U.M. Unit Unit price	Prezzo unitario Unit price Prix unitaire	Conf. std. Std. pack Cf. std
	Tappo profilo verticale fisso sx Left fixed vertical profile cap Capuchon de profil vertical fixe gauche		VTSZ-018	Pz		
	Tappo profilo verticale fisso dx Fixed right vertical profile cap Capuchon de profil vertical droit fixe		VTSZ-016	Pz		
	Tappo con perno dx Plug with right pin Fiche avec broche droite		VTSZ-022	Pz		
	Tappo con perno sx Sliding trolley with left hook Capuchon avec goupille gauche		VTSZ-021	Pz		
	Piede vetrate saliscendi Up and down glazed feet Pieds vitrés de haut en bas		VTSZ-015	Pz		
	Carrello vetrate saliscendi Up and down glazed trolley Chariot vitré haut et bas		VTSZ-001	Pz		
	Tappo prof mobile superiore dx Upper right mobile prof Prof mobile supérieur droit		VTSZ-006	Pz		
	Tappo prof mobile superiore sx Upper left mobile prof Prof mobile supérieur gauche		VTSZ-005	Pz		
	Tappo profilo mobile inferiore dx Lower right mobile profile cap Capuchon de profil mobile inférieur droit		VTSZ-012	Pz		
	Tappo profilo mobile inferiore sx Lower left mobile profile cap Capuchon de profil mobile inférieur gauche		VTSZ-017	Pz		
	Staffa centrale Central bracket Support central		VTSZ-014	Pz		

Disegno Figure Dessign	Descrizione Description Description		Codice Article Code Code Article	U.M. Unit	Prezzo unitario Unit price Prix unitaire	Conf. std. Std. pack Cf. std
	Ferma corda Cord stop Arrêt de cordon		VTSZ-013	Pz		10
	L per ferma corda L for stop rope L pour stop rope		VTSZ-009	MI		400
	Staffa angolare Angular bracket Support angulaire		VTSZ-011	MI		125
	Tappo angolare Angular cap Capuchon angulaire		VTSZ-020	MI		10
	Profilo laterale fisso Fixed side profile Profil latéral fixe	1730gr/ml	Cm 500 VTSZ5A0176	MI		10
	Profilo orizzontale Horizontal profile Profil horizontal	1007gr/ml	Cm 500 VTSZ5A0177	MI		10
	Profilo laterale mobile Movable side profile Profil latéral mobile	1050gr/ml	Cm 600 VTSZ5A0180	MI		10
	Profilo orizzontale mobile Mobile horizontal profile Profil horizontal mobile	853gr/ml	Cm 500 VTSZ5A0179	MI		10
	Profilo porta zavorra Ballast holder profile Profil de support de ballast	827gr/ml	Cm 500 VTSZ5A0178	MI		10
	Profilo angolare Angular profile Profil angulaire	976gr/ml	Cm 500 VTSZ5A0181	MI		10
	Spazzolino tcl mm 9 Brush tcl mm 9 Brosse tcl mm 9		TCL-017	MI		650

Note

A large rectangular area with horizontal dotted lines, intended for writing notes.

CALOTTE/PLUGS/ EMBOUTS

Disegno Figure	Descrizione Description		Codice Article Code	U.M. Unit	Prezzo unitario Unit price €	Conf. std. Std. pack
	Calotta con foro ø 14 Plug with hole ø 14 Embout avec trou ø 14	Ø 40	TAPF40			
		Ø 50	TAPF50			
		Ø 60	TAPF60	Pz		200
		Ø 70	TAPF70			
		Ø 80	TAPF80			
	Calotta ø 60 perno tondo Plug with round pin ø 60 Embout ø 60 avec axe rond	14x20	TAPPT60			80
		12x20	TAPPT60-1	Pz		
	Calotta ø 70 perno tondo Plug with round pin ø 70 Embout ø 70 avec axe rond	14x20	TAPPT70			80
		12x20	TAPPT70-1	Pz		
	Calotta ø 78 perno tondo Plug with round pin ø 78 Embout ø 78 avec axe rond	14x20	TAPPT78			60
		12x20	TAPPT78-1	Pz		
	Calotta ø 60 perno quadro Plug with square pin ø 60 Embout ø 60 avec axe carré	13x25	TAPPQ60-13x25			
		13x40	TAPPQ60-13x40			
		13x48	TAPPQ60-13x48	Pz		80
		13x55	TAPPQ60-13x55			
	Calotta ø 70 perno quadro Plug with square pin ø 70 Embout ø 70 avec axe carré	13x25	TAPPQ70-13x25			
		13x40	TAPPQ70-13x40			
		13x48	TAPPQ70-13x48	Pz		80
		13x55	TAPPQ70-13x55			
	Calotta ø 78 perno quadro Plug with square pin ø 78 Embout ø 78 avec axe carré	13x25	TAPPQ78-13x25			
		13x40	TAPPQ78-13x40			
		13x48	TAPPQ78-13x48	Pz		80
		13x55	TAPPQ78-13x55			
	Tappi in nylon per barra quadra Nylon caps for square bar Bouchons en nylon pour barre carrée		BQC00024A	Cp		50
	Tappo copridado Nut cover cap Cache-écrou	mm 13	TAP130005	Pz		50
		mm 17	TAP170001	Pz		50

Disegno Figure Design	Descrizione Description Description	Codice Article Code Code Article	U.M. Unit	Prezzo unitario Unit price Prix unitaire	Conf. std. Std. pack Cf. std
-----------------------------	---	--	--------------	--	------------------------------------

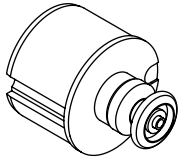

Calotta scorrevole ø 60
Plug sliding ø 60
Embout coulissant ø 60

Zincato TAPSCORZINCA
Inox TAPSCORINOX

Pz

100

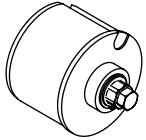

Calotta rompitratta ø 60 (Fisso) con perno
Plug windbreak ø 60 (Fixed) with pin
Embout brise-vent ø 60 (Fixe) avec axe

Zincato TAPFRAZIN60A
Inox TAPFRAINOX60ZA

Pz

100

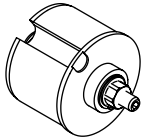

Calotta perno filettato ø 60
Plug threaded pin ø 60
Embout axe fileté ø 60

Zincato TMT000011A
Inox TMT00012A

Pz

100

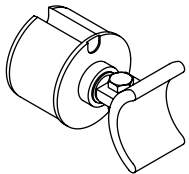

Cravatta perno e tappo ø 60
Per traverse frangivento
Cap and pin dia60 (tie) windbreak
Support axe e embout ø 60 Pour brise-vent

TMT0009A

Pz

50

ASTE DI MANOVRA/ MANEUVER AUCTIONS

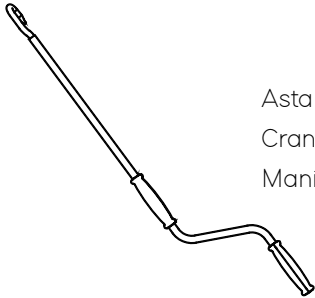

Asta di manovra verniciata
Crank handle
Manivelle

Cm 100 AST0A100
Cm 120 AST0A120
Cm 150 AST0A150
Cm 180 AST0A180
Cm 200 AST0A200
Cm 220 AST0A220
Cm 250 AST0A250
Cm 300 AST0A300

Pz

10

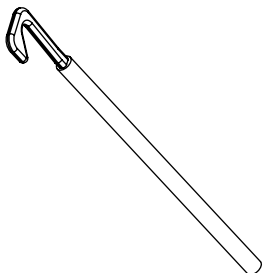

Asta per tm/tnr
Crank handle for tm/tnr
Manivelle pour tm/tnr

TM0D006

Pz

25

TUBI AVVOLGITORI/ROLLER TUBE TUBES ENROULEUR

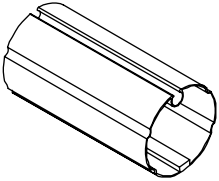
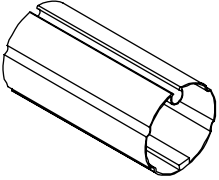
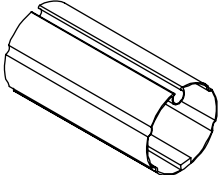

Disegno Figure Dessign	Descrizione Description Description	Codice Article Code Code Article	U.M. Unit Unit	Prezzo unitario Unit price Prix unitaire	Conf. std. Std. pack Cf. std
		Cm 300	AVV30060		
	Tubo avvolgitore ø 60	Cm 400	AVV40060		
	Winder tube ø 60	Cm 500	AVV50060	Pz	10
	Tube enrouleur ø 60	Cm 600	AVV60060		
		Cm 700	AVV70060		
		Cm 400	AVV40070		
	Tubo avvolgitore ø 70	Cm 500	AVV50070	Pz	10
	Winder tube ø 70	Cm 600	AVV60070		
	Tube enrouleur ø 70	Cm 700	AVV70070		
		Cm 400	AVV40078		
	Tubo avvolgitore ø 78	Cm 500	AVV50078	Pz	10
	Winder tube ø 78	Cm 600	AVV60078		
	Tube enrouleur ø 78	Cm 700	AVV70078		

TUBO AVVOLGITORE TENDE IN CRISTAL

	Tubo avvolgitore ø 70 ogiva schiacciata	Cm 600	AVVOS60070	Pz	10
	Rolling tube ø 70 flattened ogive	Cm 700	AVVOS70070		
	Tube roulant ø 70 ogive aplatie				

Disegno Figure Dessign	Descrizione Description Description	Codice Article Code Code Article	U.M. Unit Unit	Prezzo unitario Unit price Prix unitaire	Conf. std. Std. pack Cf. std
------------------------------	---	--	----------------------	--	------------------------------------

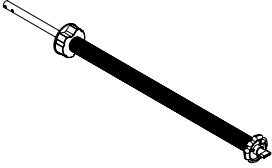
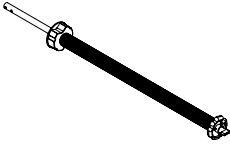
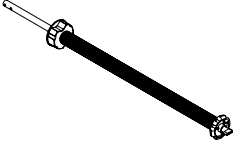
MOLLE COMPLETE

		Cm 35	MOLLA35		
		Cm 50	MOLLA50		
	Molla assemblata ø 60	Cm 70	MOLLA70	Pz	10
	Spring assembled ø 60	Cm 90	MOLLA90		
	Ressort assemblé ø.60	Cm 120	MOLLA120		
		Cm 140	MOLLA140 (Tondino pieno)		
	Molla assemblata ø 70 tondino vuoto	Cm 70	MOLLA70/70		
	Spring assembled rod empty ø 70	Cm 90	MOLLA90/70	Pz	10
	Ressort assemblé ø 70 tige vide	Cm 120	MOLLA120/70		
	Molla assemblata ø 70 tondino pieno	Cm 140	MOLLA140/70	Pz	10
	Spring assembled full rod ø 70	Cm 180	MOLLA180/70		
	Ressort assemblé ø 70 tige plein				
	Doppia molla assemblata ø 70	Cm 290	MOLLA-DOP 290	Pz	10
	Double spring assemble ø 70	Cm 360	MOLLA-DOP 360		
	Double ressort assemblé ø 70				

MOLLE/SPRINGS/RESSORTS

Disegno Figure Dessign	Descrizione Description Description	Codice Article Code Code Article	U.M. Unit	Prezzo unitario Unit price Prix unitable	Conf. std. Std. pack Cf. std
------------------------------	---	--	--------------	--	------------------------------------

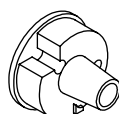

Kit portamolla ø 60
Kit spring holder ø 60
Kit porte rouleaux ø 60
Tappo portamolla ø 60
Caps for spring holder ø 60
Caps for spring holder ø 60
Conetto portamolla ø 60
Cone-holder ø 60
Cone-holder ø 60
Distanziale ø 60
Distance ø 60
Distance ø 60

KIT.0D001

TAPPOPM60

Pz

100

CONETTOPM60

DISTANZIALE60

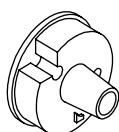

Kit portamolla ø 70
Kit spring holder ø 70
Kit porte rouleaux ø 70
Tappo portamolla ø 70
Caps for spring holder ø 70
Caps for spring holder ø 70
Conetto portamolla ø 70
Cone-holder ø 70
Cone-holder ø 70
Distanziale ø 70
Distance ø 70
Distance ø 70

KIT.0D002

TAPPOPM70

Pz

100

CONETTOPM70

DISTANZIALE70

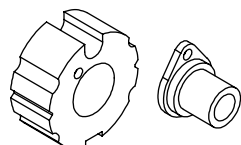

Distanziale e fermo per doppia molla 290/360
Distance and spring retainer double 290/360
Distancier et arret pour double ressort 290/360

MOLLA-DF

Pz

10

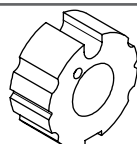

Distanziale per molla 140/180
Distance for spring from 140/180
Distancier pour ressort 140/180

MOLLA-DI

Pz

10

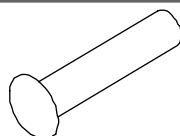

Ribattino per molla
Rivet for spring
Rivet pour ressort

MOLLA-RIB

Pz

1000

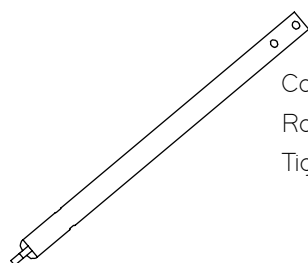

Cannetta
Rod
Tige

Cm 50 CANNA MOLLA 35
Cm 70 CANNA MOLLA 50
Cm 90 CANNA MOLLA 70
Cm 120 CANNA MOLLA 90
Cm 140 CANNA MOLLA 120
Cm 180 CANNA MOLLA 140
Cm 230 CANNA MOLLA 180

Pz

20

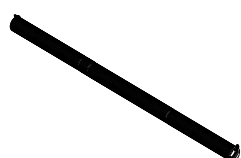

Aspirale
Spring spiral
Spirale

Cm 35 MOLLA ASP 35
Cm 50 MOLLA ASP 50
Cm 70 MOLLA ASP 70
Cm 90 MOLLA ASP 90
Cm 120 MOLLA ASP 120
Cm 140 MOLLA ASP 140
Cm 180 MOLLA ASP 180

Pz

20

BRACCI/ARMS/ARMES

Disegno Figure Dessign	Descrizione Description Description	Codice Article Code Code Article	U.M. Unit	Prezzo unitario Unit price Prix unitable	Conf. std. Std. pack Cf. std
------------------------------	---	--	--------------	--	------------------------------------

BRACCI/ARMS/ARMES Mod. BQC

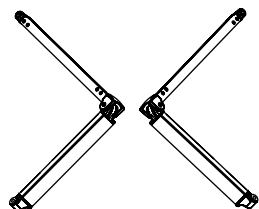

Bracci a catena
Arms with chain
Bras à chaîne

Cm 160	BRA0A160		
Cm 185	BRA0A185		
Cm 210	BRA0A210		
Cm 235	BRA0A235		
Cm 260	BRA0A260	Cp	10
Cm 285	BRA0A285		
Cm 310	BRA0A310		
Cm 360	BRA0A360		
Cm 410	BRA0A410		

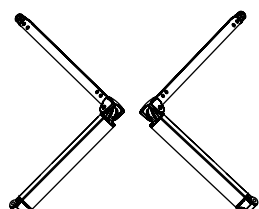

Bracci a cavetto
Arms with cable
Bras à câble

Cm 160	BQCCAV0A160		
Cm 185	BQCCAV0A185		
Cm 210	BQCCAV0A210		
Cm 235	BQCCAV0A235		
Cm 260	BQCCAV0A260	Cp	10
Cm 285	BQCCAV0A285		
Cm 310	BQCCAV0A310		
Cm 360	BQCCAV0A360		
Cm 410	BQCCAV0A410		

BRACCI/ARMS/ARMES Mod. TWISTER

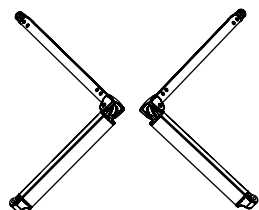

Bracci a catena twister
Arms with chain twister
Bras à chaîne twister

Cm 160	TWS0A160		
Cm 185	TWS0A185		
Cm 210	TWS0A210		
Cm 235	TWS0A235		
Cm 260	TWS0A260	Cp	10
Cm 285	TWS0A285		
Cm 310	TWS0A310		
Cm 360	TWS0A360		
Cm 410	TWS0A410		

BRACCI/ARMS/ARMES Mod. VERONA

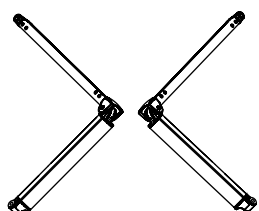

Bracci a catena
Arms with chain
Bras à chaîne

Cm 160	MIL0A160		
Cm 185	MIL0A185		
Cm 210	MIL0A210		
Cm 235	MIL0A235	Cp	10
Cm 260	MIL0A260		
Cm 285	MIL0A285		
Cm 310	MIL0A310		

Disegno Figure Design	Descrizione Description Description	Codice Article Code Code Article	U.M. Unit	Prezzo unitario Unit price Prix unitaire	Conf. std. Std. pack Cf. std
-----------------------------	---	--	--------------	--	------------------------------------

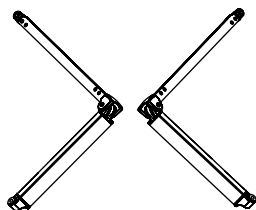

Bracci a cavetto
Arms with cable
Bras à câble

Cm 160	MIL0A160C	
Cm 185	MIL0A185C	
Cm 210	MIL0A210C	
Cm 235	MIL0A235C	Cp
Cm 260	MIL0A260C	
Cm 285	MIL0A285C	
Cm 310	MIL0A310C	

10

BRACCI/ARMS/ARMES Mod. KIRO

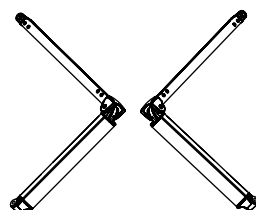

Bracci a catena
Arms with chain
Bras à chaîne

Cm 160	KIR0A160	
Cm 185	KIR0A185	
Cm 210	KIR0A210	
Cm 235	KIR0A235	Cp
Cm 260	KIR0A260	
Cm 285	KIR0A285	
Cm 310	KIR0A310	

10

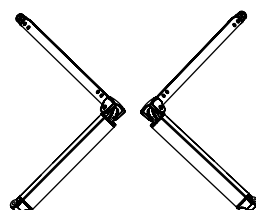

Bracci a cavetto
Arms with cable
Bras à câble

Cm 160	CAV0A160	
Cm 185	CAV0A185	
Cm 210	CAV0A210	
Cm 235	CAV0A235	Cp
Cm 260	CAV0A260	
Cm 285	CAV0A285	
Cm 310	CAV0A310	

10

BRACCI/ARMS/ARMES Mod. OMBRA

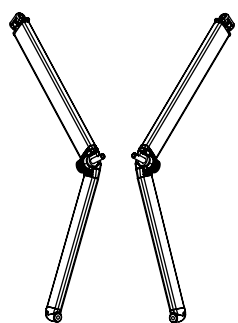

Bracci Ombra 130° A Cavetto
Arms Ombra 130° With Cable
Bras Ombra 130° À Câble

Cm 135	OMBR0A135-130	
Cm 160	OMBR0A160-130	
Cm 185	OMBR0A185-130	
Cm 210	OMBR0A210-130	
Cm 235	OMBR0A235-130	Cp
Cm 260	OMBR0A260-130	
Cm 285	OMBR0A285-130	
Cm 310	OMBR0A310-130	

10

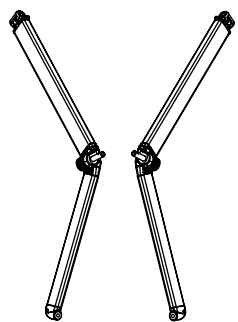

Bracci ombra 170° a cavetto
Arms ombra 170° with cable
Bras ombra 170° à câble

Cm 135	OMBR0A135-170	
Cm 160	OMBR0A160-170	
Cm 185	OMBR0A185-170	
Cm 210	OMBR0A210-170	
Cm 235	OMBR0A235-170	Cp
Cm 260	OMBR0A260-170	
Cm 285	OMBR0A285-170	
Cm 310	OMBR0A310-170	

10

BRACCI/ARMS/ARMES

Disegno Figure Dessign	Descrizione Description Description	Codice Article Code Code Article	U.M. Unit	Prezzo unitario Unit price Prix unitable	Conf. std. Std. pack Cf. std
------------------------------	---	--	--------------	--	------------------------------------

BRACCI/ARMS/ARMES Mod. BQC LED

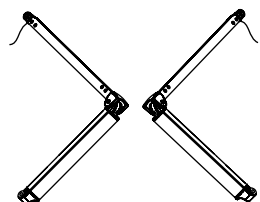

Bracci led BQC a catena
BQC led chain arms
Bras de chaîne à led BQC

Cm 160	BQC-LED-160A				
Cm 185	BQC-LED-185A				
Cm 210	BQC-LED-210A				
Cm 235	BQC-LED-235A				
Cm 260	BQC-LED-260A	Cp			10
Cm 285	BQC-LED-285A				
Cm 310	BQC-LED-310A				
Cm 360	BQC-LED-360A				
Cm 410	BQC-LED-410A				

BRACCI/ARMS/ARMES Mod. KIRO LED

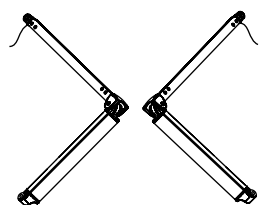

Bracci led KIRO a catena
Led KIRO chain arms
Bras de chaîne LED KIRO

Cm 160	KIRO-LED-160A				
Cm 185	KIRO-LED-185A				
Cm 210	KIRO-LED-210A				
Cm 235	KIRO-LED-235A	Cp			10
Cm 260	KIRO-LED-260A				
Cm 285	KIRO-LED-285A				
Cm 310	KIRO-LED-310A				

BRACCI/ARMS/ARMES Mod. OMBRA LED

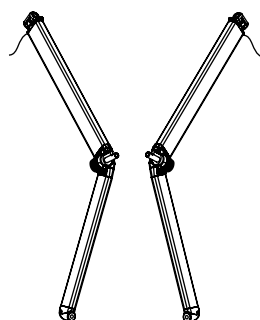

Bracci Ombra 130° A Cavetto
Arms Ombra 130° With Cable
Bras Ombra 130° À Câble

Cm 135	OMBRALED135-130				
Cm 160	OMBRALED160-130				
Cm 185	OMBRALED185-130				
Cm 210	OMBRALED210-130	Cp			10
Cm 235	OMBRALED235-130				
Cm 260	OMBRALED260-130				
Cm 285	OMBRALED285-130				
Cm 310	OMBRALED310-130				

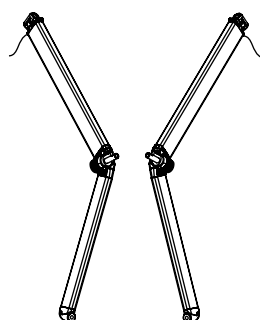

Bracci ombra 170° a cavetto
Arms ombra 170° with cable
Bras ombra 170° à câble

Cm 135	OMBRALED135-170				
Cm 160	OMBRALED160-170				
Cm 185	OMBRALED185-170				
Cm 210	OMBRALED210-170	Cp			10
Cm 235	OMBRALED235-170				
Cm 260	OMBRALED260-170				
Cm 285	OMBRALED285-170				
Cm 310	OMBRALED310-170				



VA.ILA. S.p.A.
Via Campo Gillaro, 34
00030 San Cesareo (Roma)
Tel. 06.95.59.571

e.mail: vaila@vailatende.it - ordini@vailatende.it - preventivi@vailatende.it
sito: www.vailatende.it

